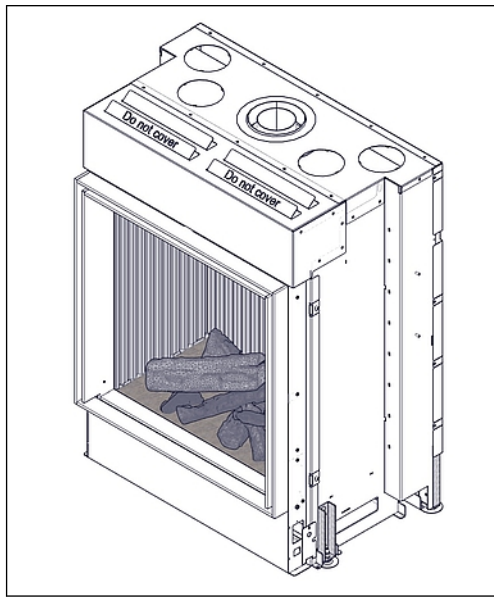
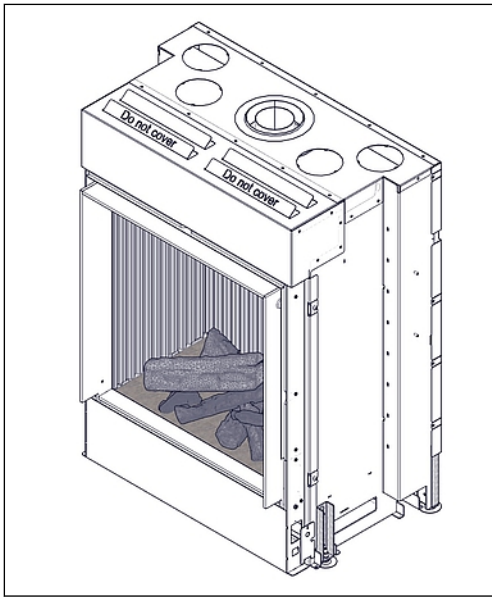


barbas .

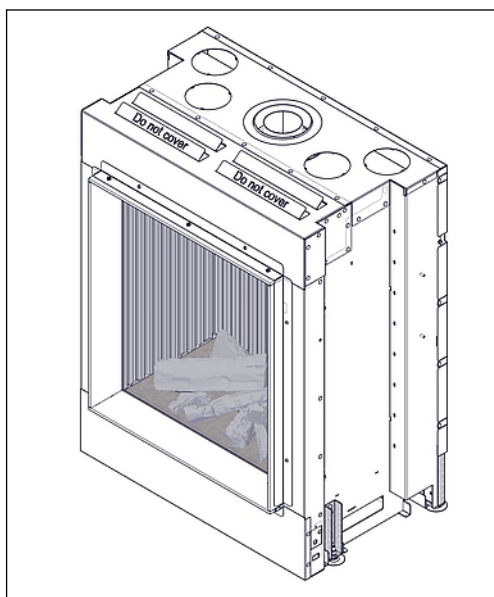
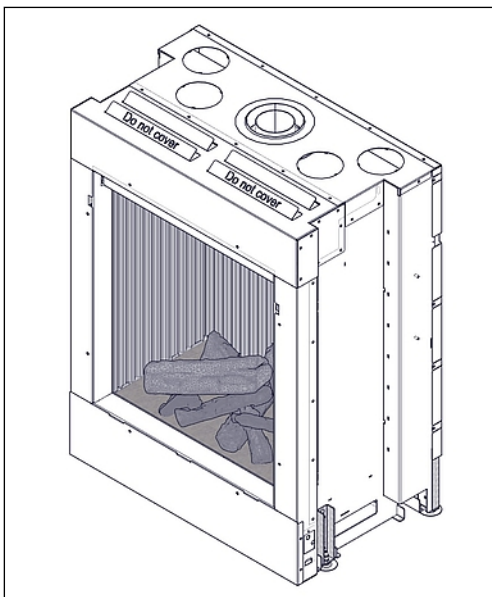
Preparation manual

Gas Fire Front 110-60 PF2

---- Floating Frame ----- Floating Frame + ----



---- Hidden Door ----- Hidden Door + ----



Serial number:

Production date:

© Barbas Bellfires BV

This document or parts thereof may not be reproduced, stored in a retrieval system, or transmitted, in any form or by any means, electronic, mechanical, photocopying, recording, nor otherwise, without the prior written permission of Barbas Bellfires BV. This document could contain technical inaccuracies or typographical errors. Barbas Bellfires BV reserves the right to revise this document from time to time in the contents thereof.

Contact information

Barbas Bellfires BV

Hallenstraat 17, 5531 AB Bladel, The Netherlands

Phone: +31 49 733 9200

E-mail: info@barbas.com

Contents

1	About this document.....	4
1.1	How to work with this document.....	4
1.2	Warnings and cautions used in this document.....	4
1.3	Related documentation.....	4
2	Overview of the concentric flue system.....	5
3	Safety.....	6
3.1	Safety instructions for installation.....	6
4	Requirements.....	7
4.1	Requirements on the location.....	7
4.2	Requirements on the convection package (option).....	7
4.3	Other requirements.....	7
4.4	Requirements on the roof and wall outlet.....	8
4.5	Requirements on the concentric flue system.....	10
4.5.1	Possibilities for a concentric flue system with a roof outlet.....	11
4.5.2	Possibilities for a concentric flue system with a wall outlet.....	17
5	Technical specification.....	22
5.1	Gas Fire Front 110-60 PF2 with Floating Frame.....	22
5.2	Gas Fire Front 110-60 PF2 with Floating Frame +.....	23
5.3	Gas Fire Front 110-60 PF2 with Floating Frame and adjustable legs.....	24
5.4	Gas Fire Front 110-60 PF2 with Hidden Door.....	25
5.5	Gas Fire Front 110-60 PF2 with Hidden Door +.....	26
5.6	Gas Fire Front 110-60 PF2 with Hidden Door and adjustable legs.....	27
5.7	Gas Fire Front 110-60 PF2 with Hidden Door and convection casing.....	28
5.8	Gas Fire Front 110-60 PF2 with Floating Frame + and convection casing.....	29
5.9	Dimensions of the restriction plate.....	30
6	Available components for the concentric flue system - natural draught.....	31
6.1	Appliance part list.....	31
6.2	Bellfires - Muelink & Grol system Ø100 - Ø150.....	32
6.3	Bellfires - Muelink & Grol system Ø130 - Ø200.....	38
6.4	Poujoulat - DUOGAS system Ø100 - Ø150.....	42
6.5	Poujoulat - DUOGAS system Ø130 - Ø200.....	45
6.6	Ontop - Metaloterm US system Ø100 - Ø150.....	47
6.7	Ontop - Metaloterm US system Ø130 - Ø200.....	51
6.8	Jeremias/STB - H-Twin system Ø100 - Ø150.....	56
6.9	Jeremias/STB - H-Twin system Ø130 - Ø200.....	60
6.10	Jeremias - TWIN-GAS system Ø100 - Ø150.....	63
6.11	Jeremias - TWIN-GAS system Ø130 - Ø200.....	69
6.12	Modinox - PLA system Ø100 - Ø153.....	75
6.13	Modinox - PLA system Ø130 - Ø200.....	85

1 About this document

This document shows the necessary information to do these tasks on the Gas Fire Front 110-60 PF2:

- Preparation for installation

This document refers to the Gas Fire Front 110-60 PF2 as 'the appliance'. This document is an essential part of your appliance. Read it carefully before you do work on the appliance. Keep it in a safe place.

The original instructions of the document are in English. All other language versions of the document are translations of the original instructions. It is not always possible to provide a detailed illustration of every single item of the equipment. The illustrations in this document show a typical setup. The illustrations are for instructional use only.

1.1 How to work with this document

1. Make yourself familiar with the structure and content of the document.
2. Read the safety section in detail.
3. Make sure that you understand all the instructions.
4. Do the procedures completely and in the given sequence.

1.2 Warnings and cautions used in this document

Warning



If you do not obey these instructions, there is a risk that can cause personal injury or death.

Caution

If you do not obey these instructions, there is a risk of damage to the equipment or to property.

Note

A note shows more information.

Symbol	Description
	Visual sign that there is a hazard
	Visual sign that there is a notice

1.3 Related documentation

- Preparation manual
- Installation and maintenance manual
- User manual
- Assembly instructions for concentric flue system

2 Overview of the concentric flue system

The concentric flue system provides the appliance with combustion air and removes the flue gases from the appliance. The concentric flue system is made of these items:

Item	Description
Concentric flue	The concentric flue is a pipe with an inner pipe. The inner pipe is used as flue gas channel and the space between the inner pipe and the outer pipe is used as combustion air channel
Flue gas channel	The flue gases from the appliance flow through the channel to the outlet by natural draught or, with the Opti-Vent installed, forced draught.
Combustion air channel	Supplies the appliance with fresh air from the outlet through the channel
Outlet/terminal	Entry for the combustion air channel and exit for the flue gas channel

3 Safety

3.1 Safety instructions for installation



Caution:

- The appliance must be installed as a 'room sealed system' appliance by a certified and registered gas installation engineer in accordance with the supplied installation instructions, and nationally and locally applicable regulations.
- If you have any questions regarding the installation, consult your local gas company.
- Before the installation starts, make sure that the details on the rating plate correspond with the gas type and supply pressure as intended for the appliance.
- Only use items in the installation that are specified in this manual and the related documents.
- Only use the following brands for the installation of the concentric flue system:

Manufacturer	System	Flue gas extraction
Bellfires	Muelink & Grol system	Natural draught
Poujoulat	DUOGAS system	Natural draught
Ontop	Metaloterm US system	Natural draught
Jeremias/STB (STB = Schoorsteen Techniek-Brummen NL)	H-Twin system	Natural draught
Jeremias	TWIN-GAS system	Natural draught
Modinox	PLA system	Natural draught
Barbas	Opti-Vent system ¹	Forced draught

- Do not use a combination of parts from different brands for the installation of the concentric flue system.
- All concentric flue systems in this list can be installed with (prefabricated) building materials that are suitable for T400 or higher. (T400 as described in the standard: prEN 1856-1; Chimneys - Requirements for metal chimneys - Part 1: System chimney products). Concerns building materials according to DIN 18160 Chimney systems.

¹ For installation and use of the Opti-Vent system refer to the Barbas manual "installation and maintenance manual Opti-Vent system.

4 Requirements

4.1 Requirements on the location

- Never use combustible building materials for the fireplace.
- Do not install the appliance against a flammable rear wall.
- Install a non-flammable insulation plate of at least 12 mm between the appliance and a non-flammable rear wall. The insulation plate must cover the entire area of the rear of the appliance.
- For details about the installation, minimum clearances to flammable materials, permitted insulation materials and air gaps, refer to the "installation and maintenance manual".
- If the fire burns in the appliance, make sure that the floor temperatures below and in front of the appliance cannot be higher than 85 °C .
- Make sure that the room where the appliance is installed is properly ventilated.

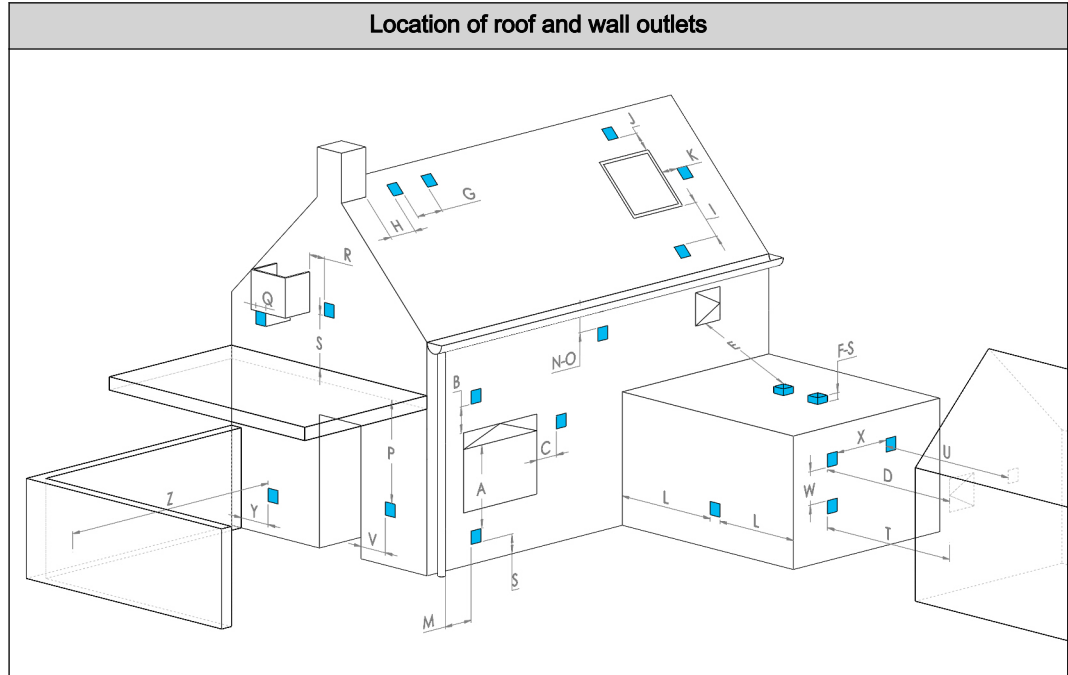
4.2 Requirements on the convection package (option)

- The convection outlet opening must be at least 0,5 meter above the appliance.
- No flammable material is present within 10 cm on both sides and 20 cm above the convection outlet opening.
- The convection outlet opening must be at least 15 cm below the ceiling.

4.3 Other requirements

- The gas supply connection is located near the right side of the appliance for an easy connection.
- Only use gas piping of at least ½" and a shut-off valve to connect the gas supply to the gas connection of the appliance.
- Make sure that there is a wall socket with an earth connection nearby the appliance. The socket must be accessible at all times. The power cable (+/- 0.5 m) is coming from the right side of the appliance.
- Install the fireplace on a solid floor that can bear the weight of the appliance and the fireplace.
- If the floor is made of flammable material, take correct safety measures. Install a temperature protection plate made of nonflammable material between the appliance and the floor.
- Install the appliance as a built-in appliance in a new fireplace.
- If the concentric flue system is installed in an existing chimney that is used for wood or coal fire, clean the chimney.
- If you built a new fireplace, make sure that it is ventilated with vents at the bottom and top of the fireplace. If the fireplace is not ventilated the temperature of the appliance can increase to dangerous temperatures and damage the fireplace.
- Keep a minimum distance between the appliance and flammable mantelpieces. Refer to the chapter "Mantelpiece clearances" in the "installation and maintenance manual": for the correct minimum clearances.

4.4 Requirements on the roof and wall outlet



Refer to the table hereunder for explanation of the figure.



Note: All the minimum distances in the table are guidelines. Consult your national and local regulations for the exact minimum distances.

Minimum separation distances for roof and wall outlet(terminal) in mm		
Location		Minimum distance [mm]
A	Below an opening ² on the same wall/roof	2000
B	Above an opening ³ on the same wall/roof	700
C	Horizontally to an opening ³ on the same wall/roof	700
D	Horizontally to a facing opening ³ in a opposite wall	2000
E	From a roof terminal under an opening ³ in a nearby rising wall	4000
F	Above a flat or pitched roof	300
G	Horizontally from a terminal on the same roof	300
H	From a structure (e.g. brick chimney) on the roof	300
I	Below a roof window in a pitched roof	2000
J	Above a roof window in a pitched roof	600
K	Horizontally to a roof window in a pitched roof	600
L	From an internal or external corner	500
M	From a vertical drainpipe or soil pipe	300
N	Below gutters, soil pipes or drainpipes, made of flammable materials	500
	Below gutters, soil pipes or drainpipes, made of non-flammable materials	300
O	Below eaves, made of flammable material	500
	Below eaves, made of non-flammable material	300
P	Below balcony ³ or car port roof	2000
Q	Beyond the balcony ⁴ edge	0
R	On either side of a balcony ⁴	1500
S	Above ground, roof or balcony ⁴ level	300
T	From a surface facing the terminal	500
U	From a terminal facing the terminal (at the same height)	600
V	From an opening in the car port into the building	1200
W	Vertically from a terminal on the same wall	1200
X	Horizontally from a terminal on the same wall	300
Y	From a boundary alongside the terminal	1000
Z	From a boundary facing the terminal	2000

- If the outlet is installed less than 0.5 m horizontally and less than 2 m vertically from a public area, install an effective protector.
- Make sure that the mesh size of the guard does not effect the operation of the appliance.
- If the height of the outlet is less than 3 meter from the floor, the distance between the outlet and a garden or a terrace must be minimum 2 meter.

² An opening here means an element that is permanent open (example: an air vent) or that can open (example: a door or window). But, in addition, the distance between outlet and built-in elements (example: window, door) must be minimum 300 mm.

³ Balcony or gallery of an apartment building.

4.5 Requirements on the concentric flue system

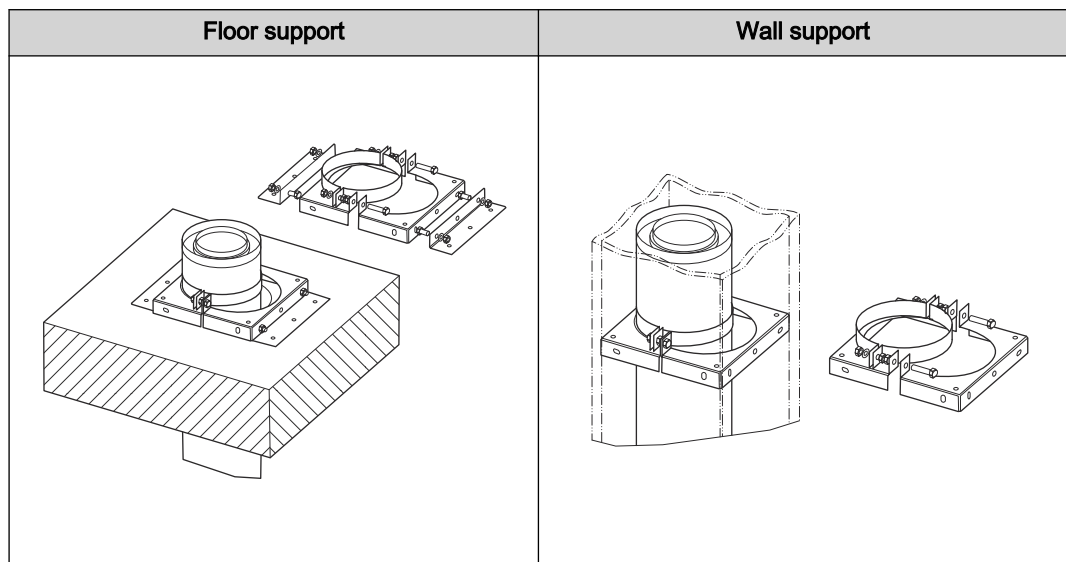


Caution:

- Make sure that no flammable materials are located close to the flue system. The outer walls of the flue system can be 150 °C.
- Make sure that the concentric flue system is in a casing.
 - Make sure that the casing is made of heat resistant material.
 - Make sure that air can flow in the casing. Use grates near the floor and near the ceiling. Do this for every floor where the casing is located.
- Do not insulate the concentric flue.

The parts that are required for the installation of the concentric flue system are numbered in the illustrations and refer to the part list in [6](#).

Use the universal wall/floor support (number 36 in the part list) to attach the concentric flue system to the casing and/or the floor.



Install a concentric flue system as described in this section.

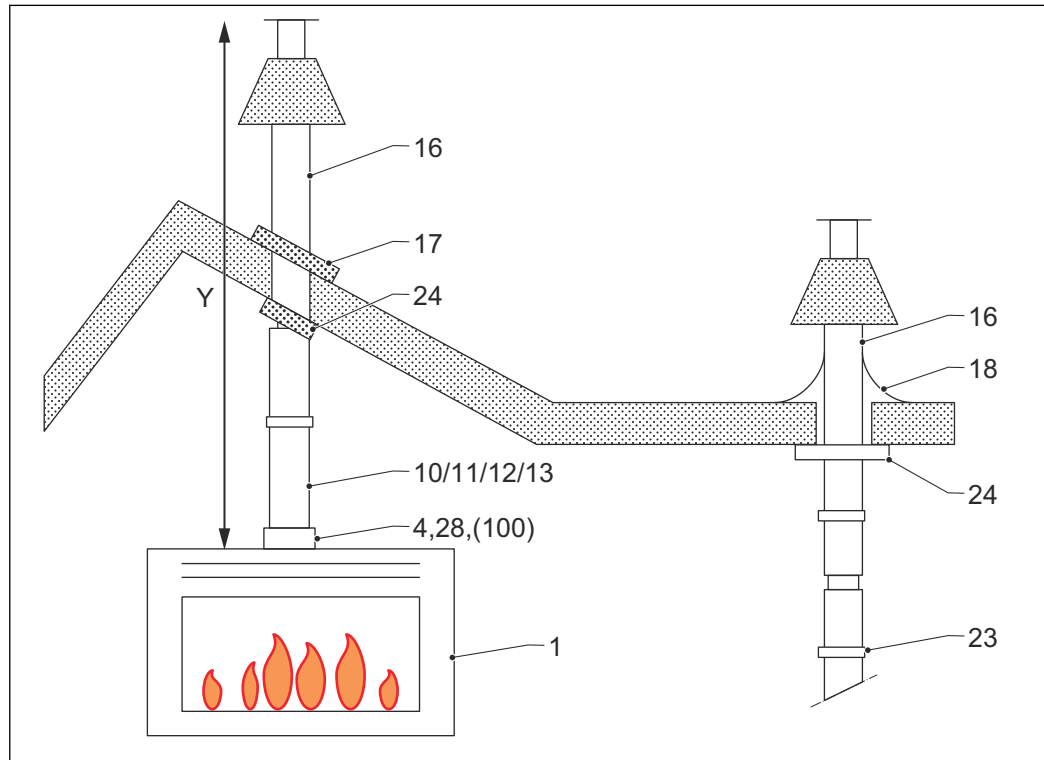
Some configurations of the concentric flue system require the installation of a flue restriction plate. Different sizes of the flue restriction plate are delivered with the appliance. Refer to the Installation and maintenance manual.

4.5.1 Possibilities for a concentric flue system with a roof outlet

Rigid concentric flue systems

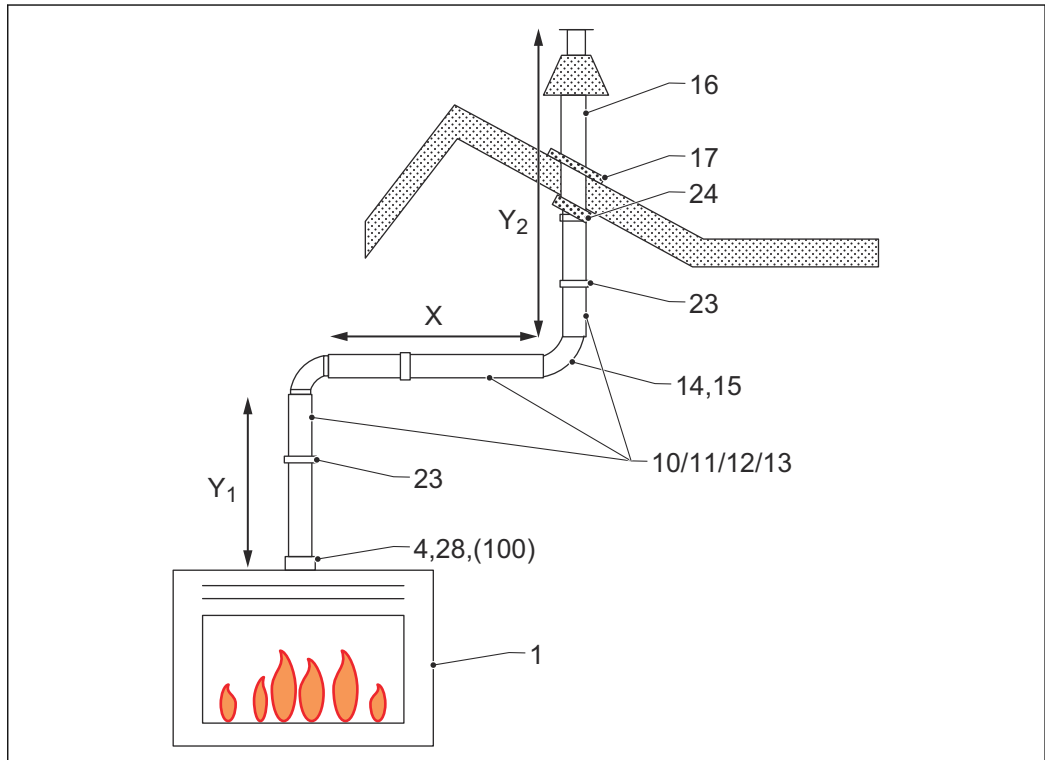


Note: Refer to chapter 6 for a description of the numbers in the figures.



Concentric flue connection on appliance $\varnothing 100\text{-}\varnothing 150$ mm or $\varnothing 130\text{-}\varnothing 200$ mm

Y (min. - max.)	Flue gas restriction plate width	
	Concentric connection on the appliance is $\varnothing 100\text{-}\varnothing 150$ mm	Concentric connection on the appliance is $\varnothing 130\text{-}\varnothing 200$ mm
2.0 - 4.0 m	30 mm	65 mm
4.0 - 12.0 m	40 mm	80 mm



Concentric flue connection on appliance Ø100-Ø150 mm or Ø130-Ø200 mm

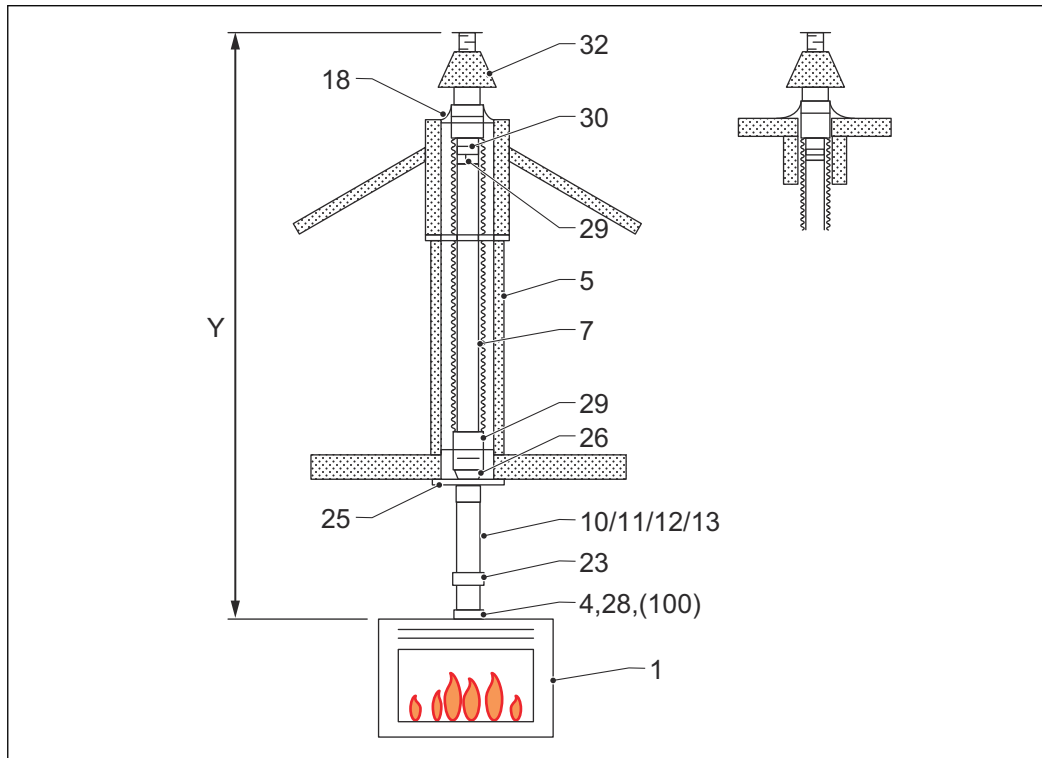
Y ₁ (min. - max.)	X (min. - max.)	Y ₁ + Y ₂ (min. - max.)	Flue gas restriction plate width	
			Concentric connection on the appliance is Ø100-Ø150 mm	Concentric connection on the appliance is Ø130-Ø200 mm
1.0 - 11.0 m	0 - 3.0 m	2.0 - 11.0 m	-	40 mm

Caution:



Make sure that Y₁ + Y₂ is at least 2 times larger than X.

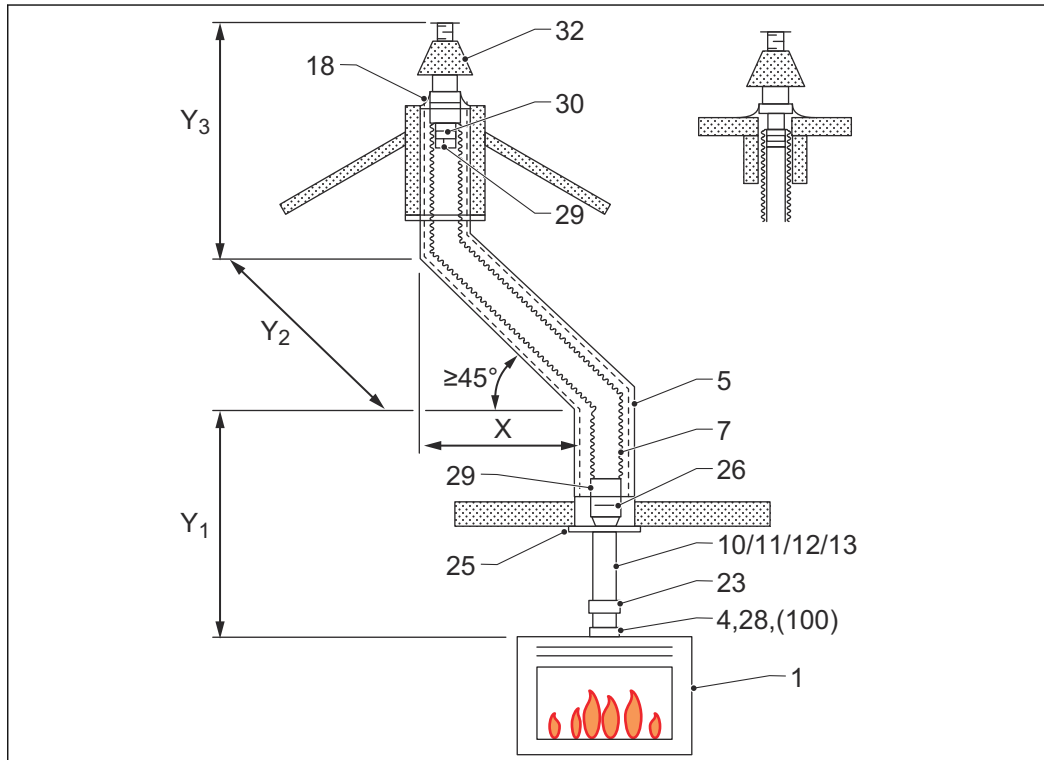
Flexible concentric flue systems



Concentric flue connection on appliance $\varnothing 100\text{-}\varnothing 150$ mm or $\varnothing 130\text{-}\varnothing 200$ mm

Y (min. - max.)	Flue gas restriction plate width	
	Concentric connection on the appliance is $\varnothing 100\text{-}\varnothing 150$ mm	Concentric connection on the appliance is $\varnothing 130\text{-}\varnothing 200$ mm
2.0 - 4.0 m	30 mm	65 mm
4.0 - 12.0 m	40 mm	80 mm

Roof outlet using an flexible $\varnothing 100$ mm liner in an existing lined chimney.



Concentric flue connection on appliance Ø100-Ø150 mm or Ø130-Ø200 mm

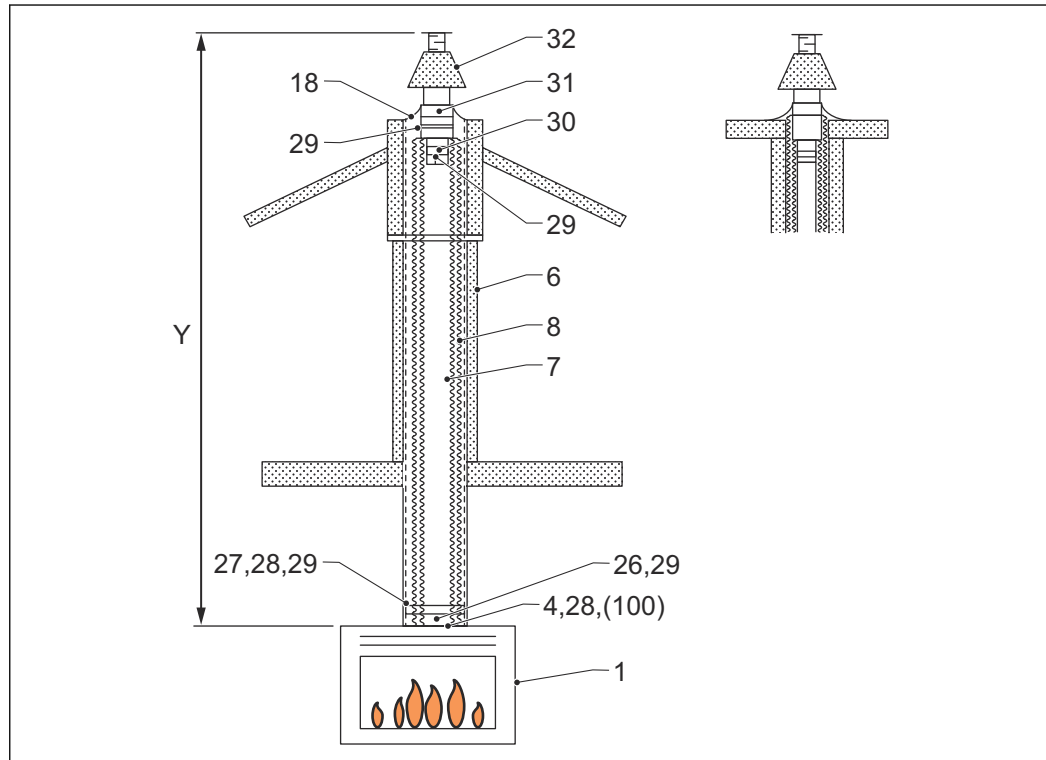
Y ₁ (min. - max.)	X (min. - max.)	Y ₁ + Y ₂ + Y ₃ (min. - max.)	Flue gas restriction plate width	
			Concentric connection on the appliance is Ø100-Ø150 mm	Concentric connection on the appliance is Ø130-Ø200 mm
1.0 - 11.0 m	0 - 3.0 m	2.0 - 11.0 m	-	40 mm



Caution:

Make sure that $Y_1 + Y_2 + Y_3$ is at least 2 times larger than X.

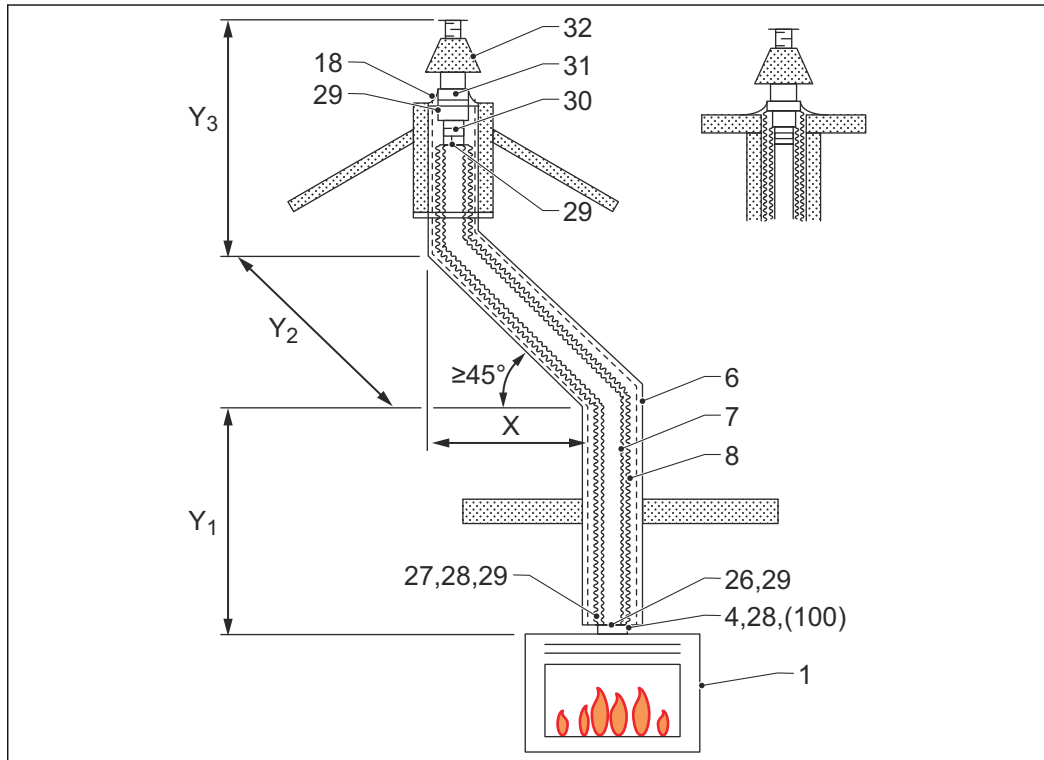
Roof outlet using a flexible Ø100 mm liner in an existing lined chimney.



Concentric flue connection on appliance Ø100-Ø150 mm or Ø130-Ø200 mm

Y (min. - max.)	Flue gas restriction plate width	
	Concentric connection on the appliance is Ø100-Ø150 mm	Concentric connection on the appliance is Ø130-Ø200 mm
2.0 - 4.0 m	30 mm	65 mm
4.0 - 12.0 m	40 mm	80 mm

Roof outlet using an flexible Ø100 mm liner and flexible Ø150 mm liner in an existing unsound lined chimney.



Concentric flue connection on appliance Ø100-Ø150 mm or Ø130-Ø200 mm

Y ₁ (min. - max.)	X (min. - max.)	Y ₁ + Y ₂ + Y ₃ (min. - max.)	Flue gas restriction plate width	
			Concentric connection on the appliance is Ø100-Ø150 mm	Concentric connection on the appliance is Ø130-Ø200 mm
1.0 - 11.0 m	0 - 3.0 m	2.0 - 11.0 m	-	40 mm

Caution:



Make sure that $Y_1 + Y_2 + Y_3$ is at least 2 times larger than X.

Roof outlet using an flexible Ø100 mm liner and flexible Ø150 mm liner in an existing unsound lined chimney.

4.5.2 Possibilities for a concentric flue system with a wall outlet

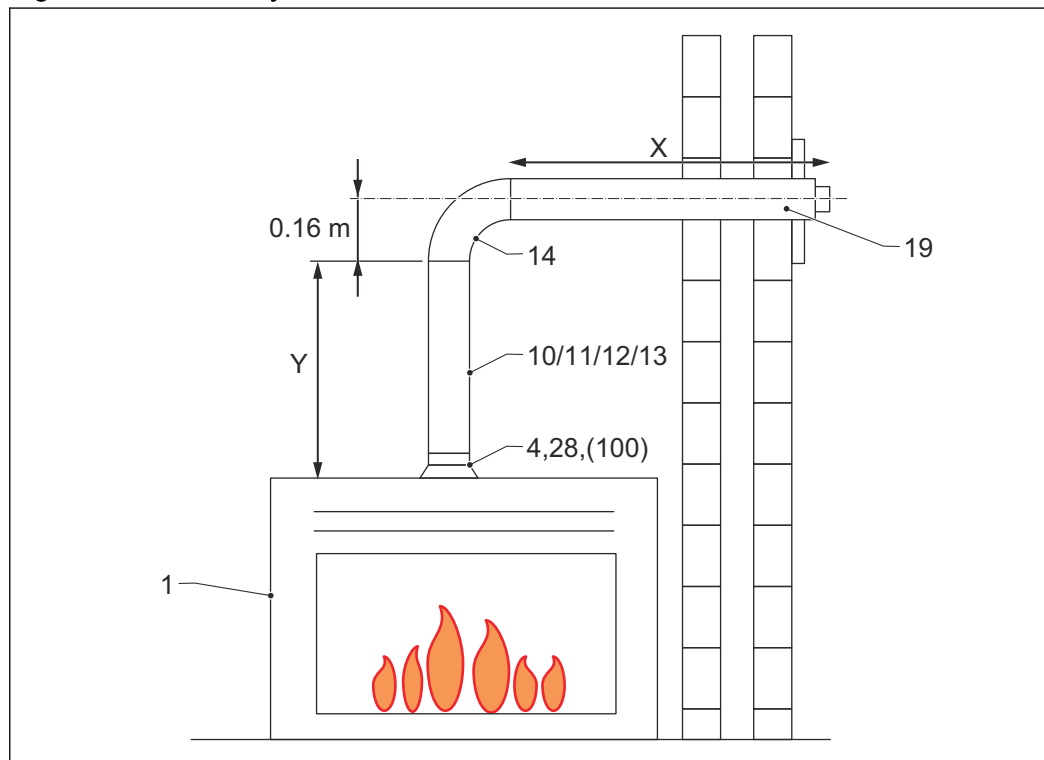


Note: Refer to chapter 6 for a description of the numbers in the figures.

Install the wall outlet in the correct position as shown in the figure. The centre of the inner pipe must be positioned above the centre of the outer pipe.

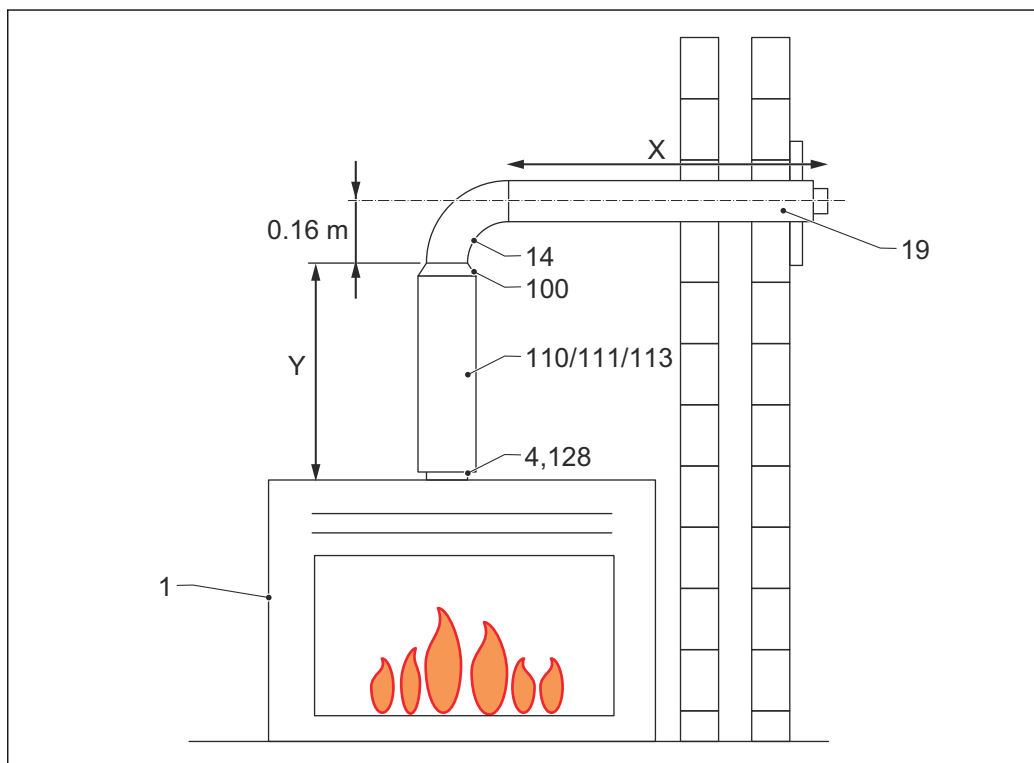


Rigid concentric flue systems



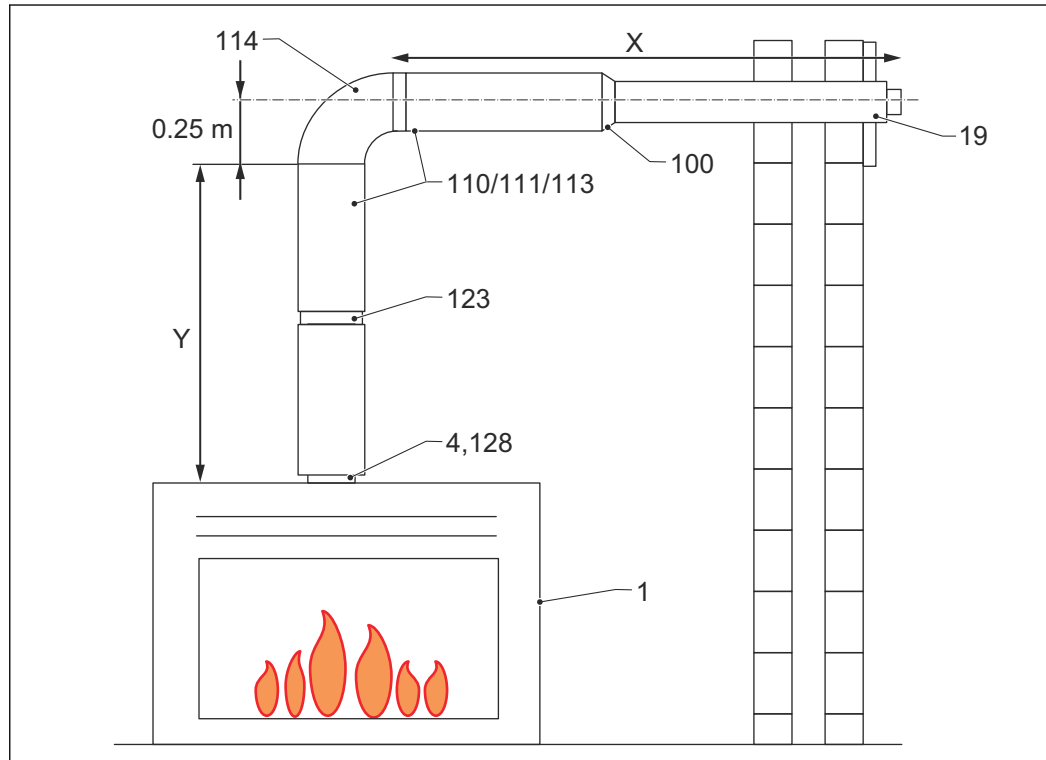
Concentric flue connection on appliance $\text{\O}100\text{-}\text{\O}150$ mm or $\text{\O}130\text{-}\text{\O}200$ mm

Y (min. - max.)	X (min. - max.)	Flue gas restriction plate	
		Concentric connection on the appliance is $\text{\O}100\text{-}\text{\O}150$ mm	Concentric connection on the appliance is $\text{\O}130\text{-}\text{\O}200$ mm
1.5 - 2.5 m	0 - 0.6 m	-	-
2.5 - 3.5 m	0 - 1.6 m	-	-



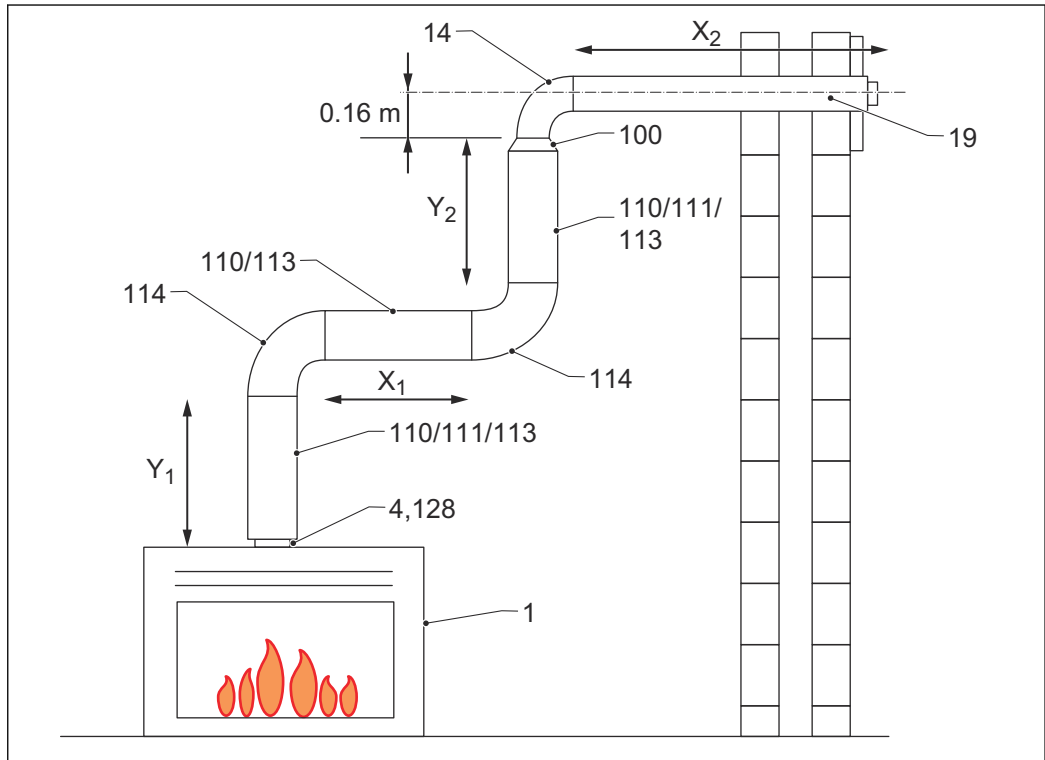
Concentric flue connection on appliance Ø130-Ø200 mm

Y (min. - max.)	X (min. - max.)	Flue gas restriction plate width
		Concentric connection on the appliance is Ø130-Ø200 mm
0.5 - 1.0 m	0 - 0.6 m	-
1.0 - 2.0 m	0 - 2.6 m	-



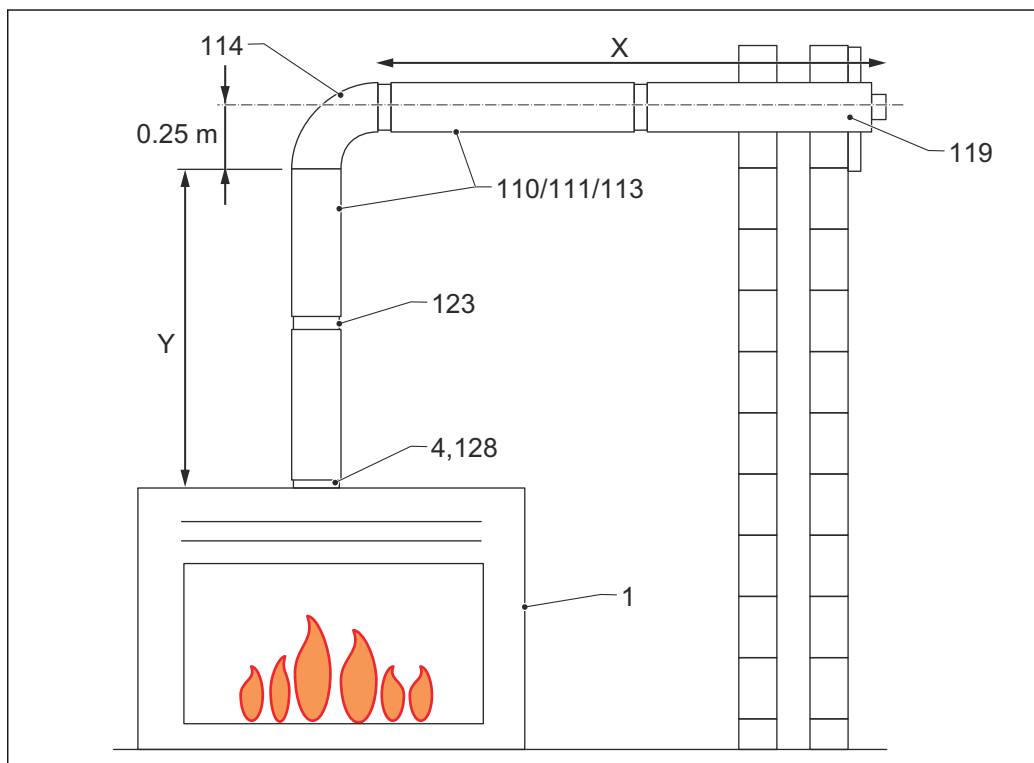
Concentric flue connection on appliance Ø130-Ø200 mm

Y (min. - max.)	X (min. - max.)	Flue gas restriction plate width
		Concentric connection on the appliance is Ø130-Ø200 mm
0.5 - 1.0 m	0 - 1.6 m	-
1.0 - 3.0 m	0 - 4.6 m	-



Concentric flue connection on appliance Ø130-Ø200 mm

Y ₁ (min. - max.)	X ₁ (min. - max.)	Y ₂ (min. - max.)	X ₂ (min. - max.)	Flue gas restriction plate width
				Concentric connection on the appliance is Ø130-Ø200 mm
0 - 0.5 m	0 - 0.5 m	0.5 - 1.0 m	0 - 0.6 m	-
0.5 - 1.0 m	0 - 0.5 m	0 - 0.5 m	0 - 0.6 m	-
1.0 - 3.0 m	0 - 1.0 m	0.5 - 2.0 m	0 - 0.6 m	-
1.0 - 3.0 m	0 - 3.0 m	1.0 - 3.0 m	0 - 0.6 m	-

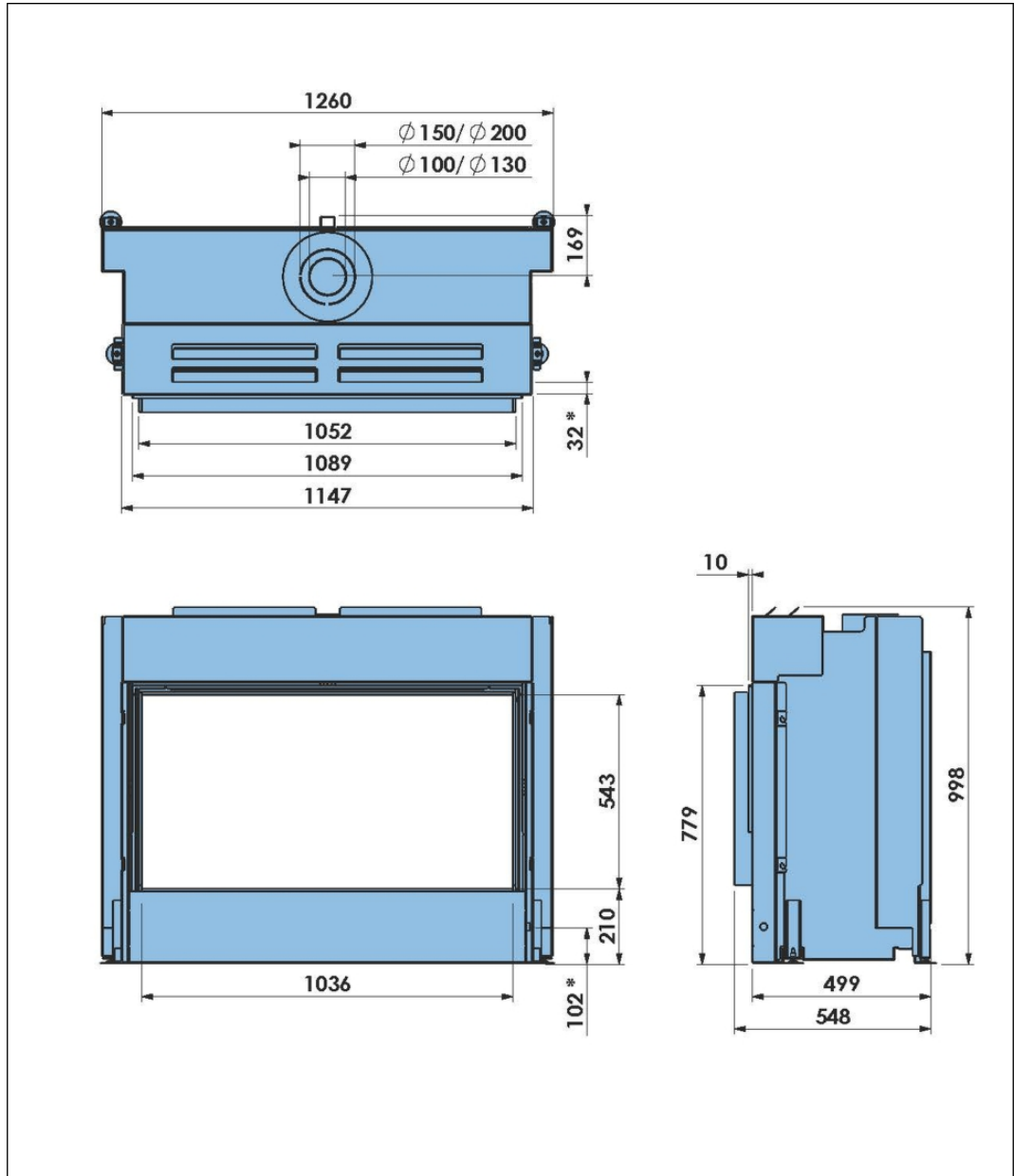


Concentric flue connection on appliance Ø130-Ø200 mm

Y (min. - max.)	X (min. - max.)	Flue gas restriction plate width
		Concentric connection on the appliance is Ø130-Ø200 mm
0 - 0.5 m	0 - 0.6 m	-
0.5 - 1.0 m	0 - 3.6 m	-
1.0 - 3.0 m	0 - 8.6 m	-

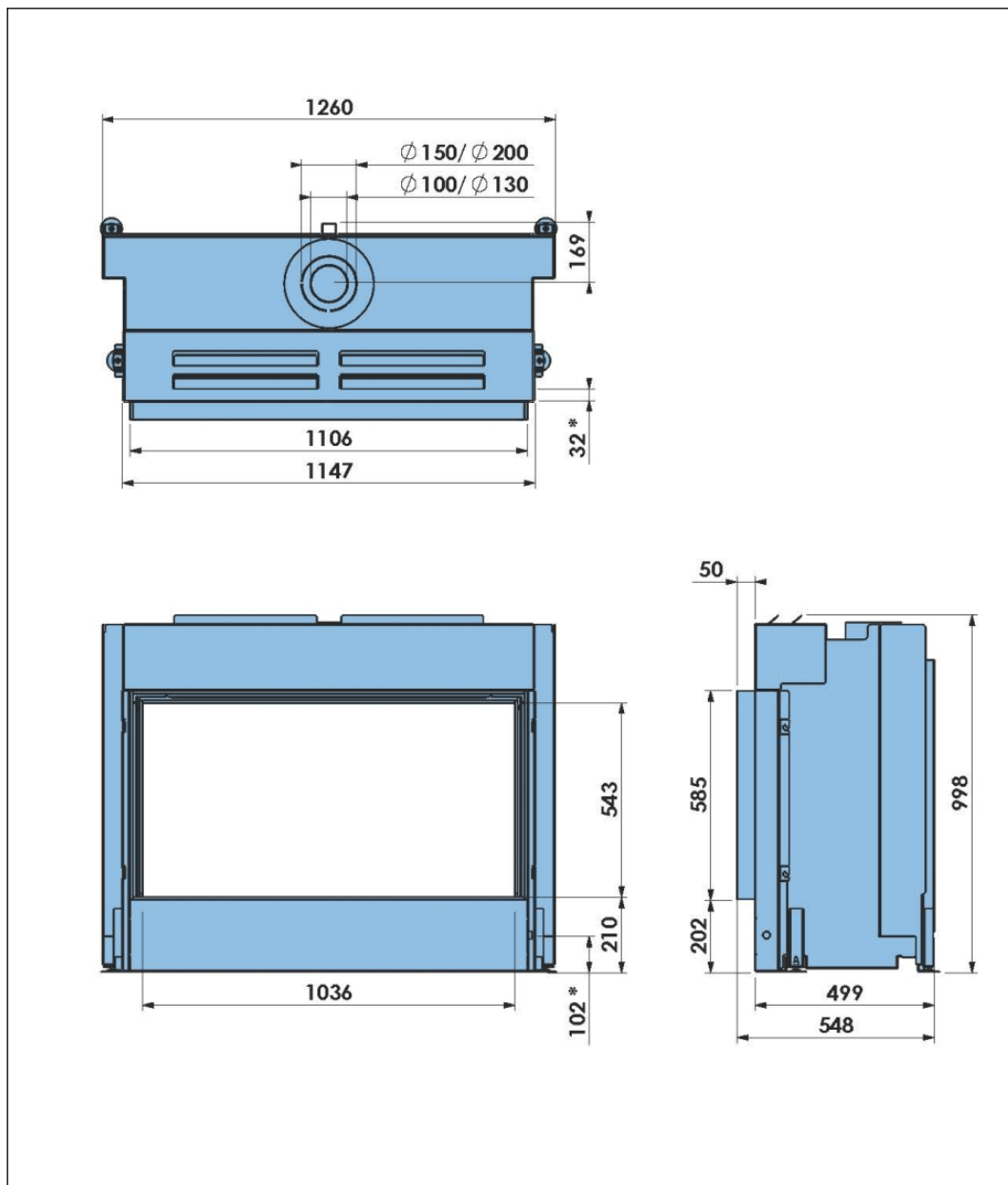
5 Technical specification

5.1 Gas Fire Front 110-60 PF2 with Floating Frame



* = Gas connection

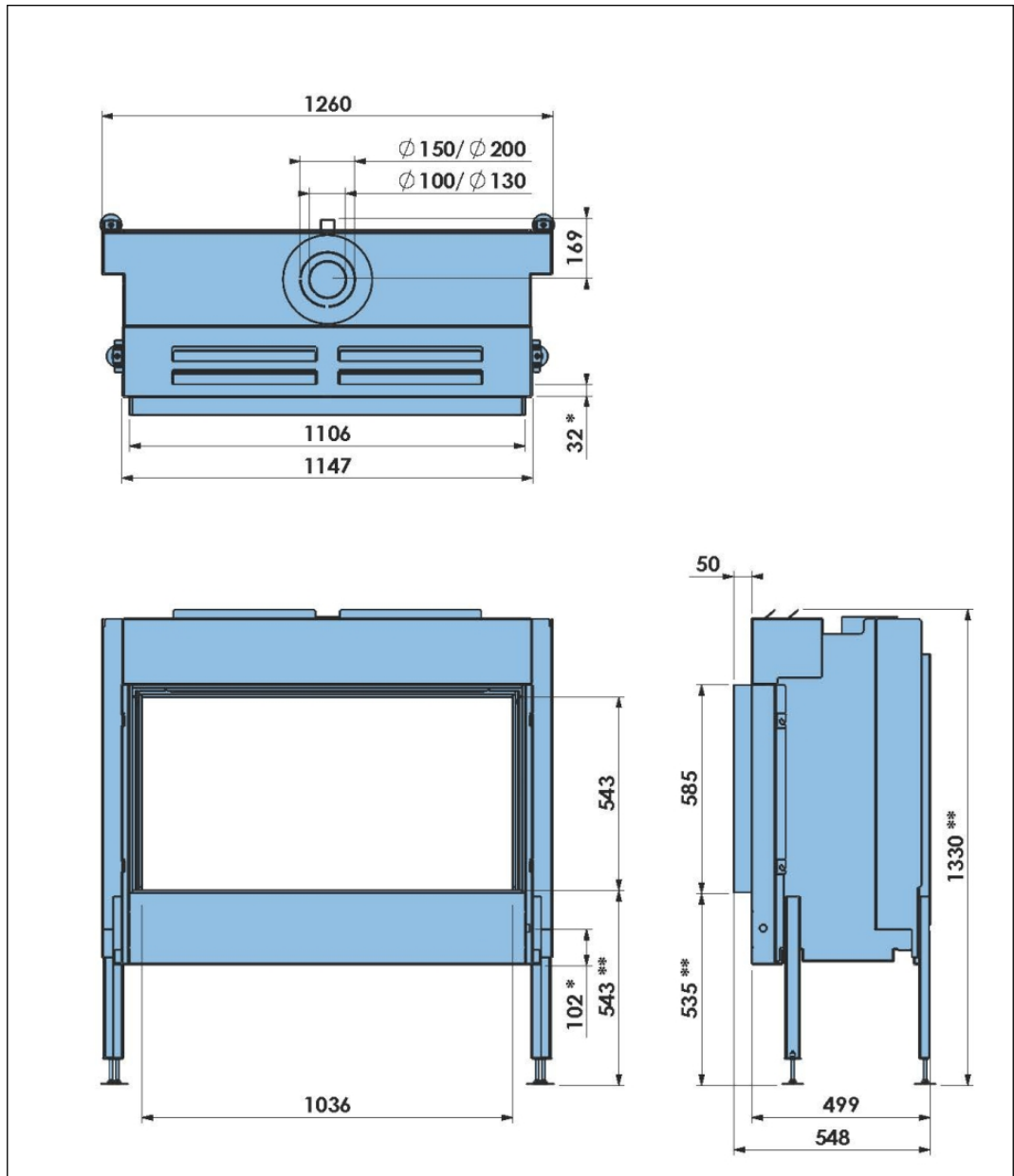
5.2 Gas Fire Front 110-60 PF2 with Floating Frame +



* = Gas connection

5.3 Gas Fire Front 110-60 PF2 with Floating Frame and adjustable legs

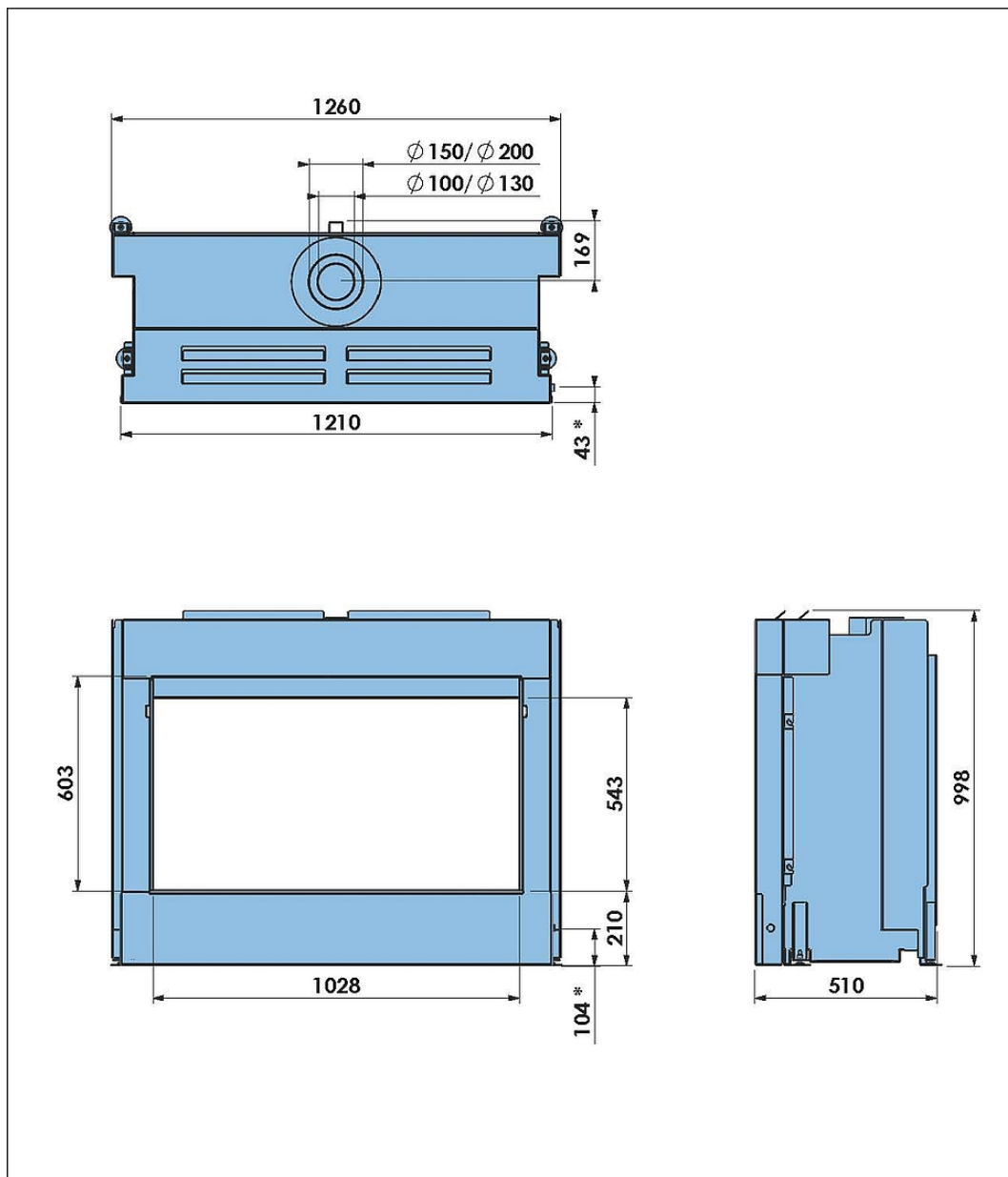
With optional adjustable legs



* = Gas connection

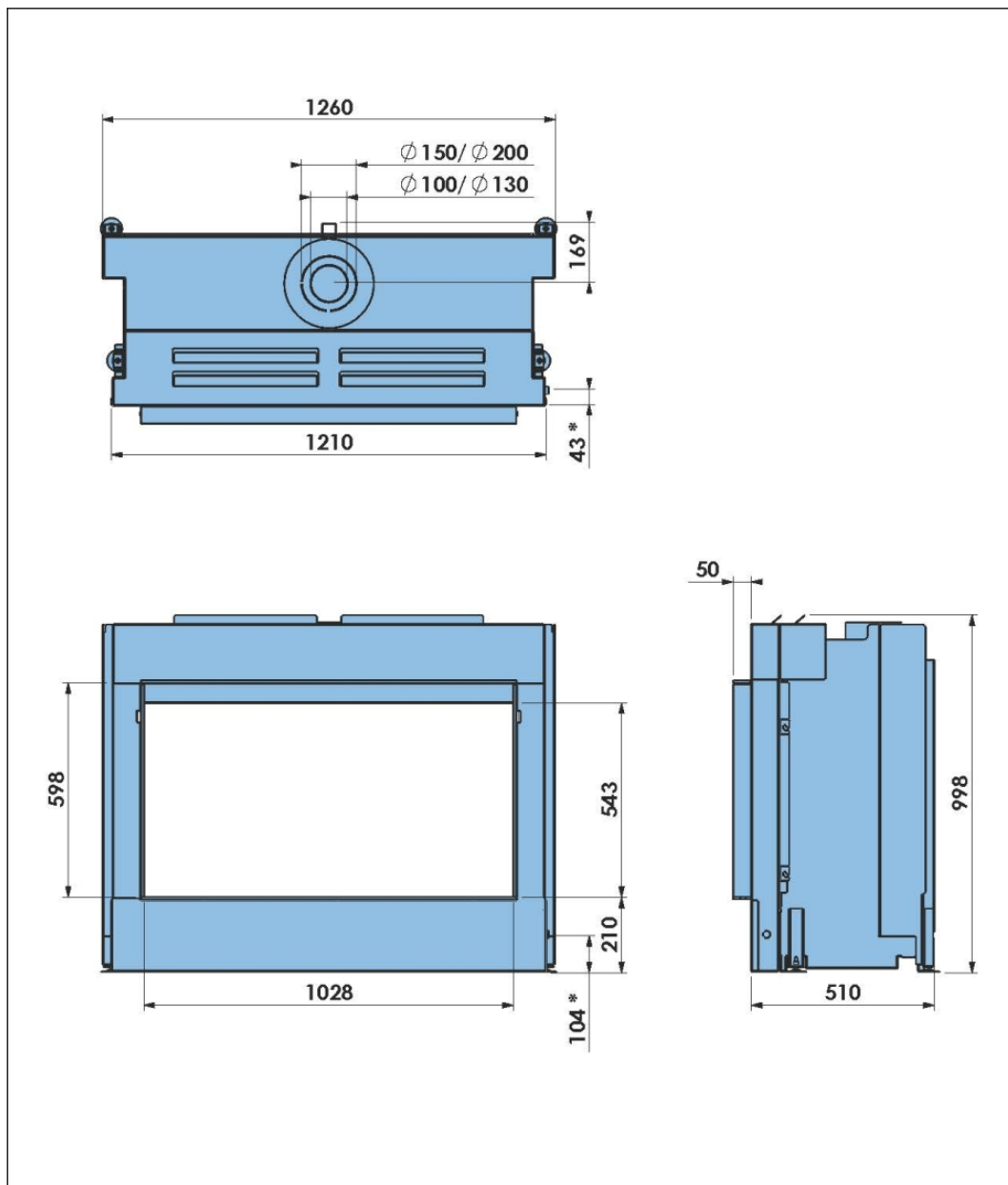
** = Maximum height with adjustable legs

5.4 Gas Fire Front 110-60 PF2 with Hidden Door



* = Gas connection

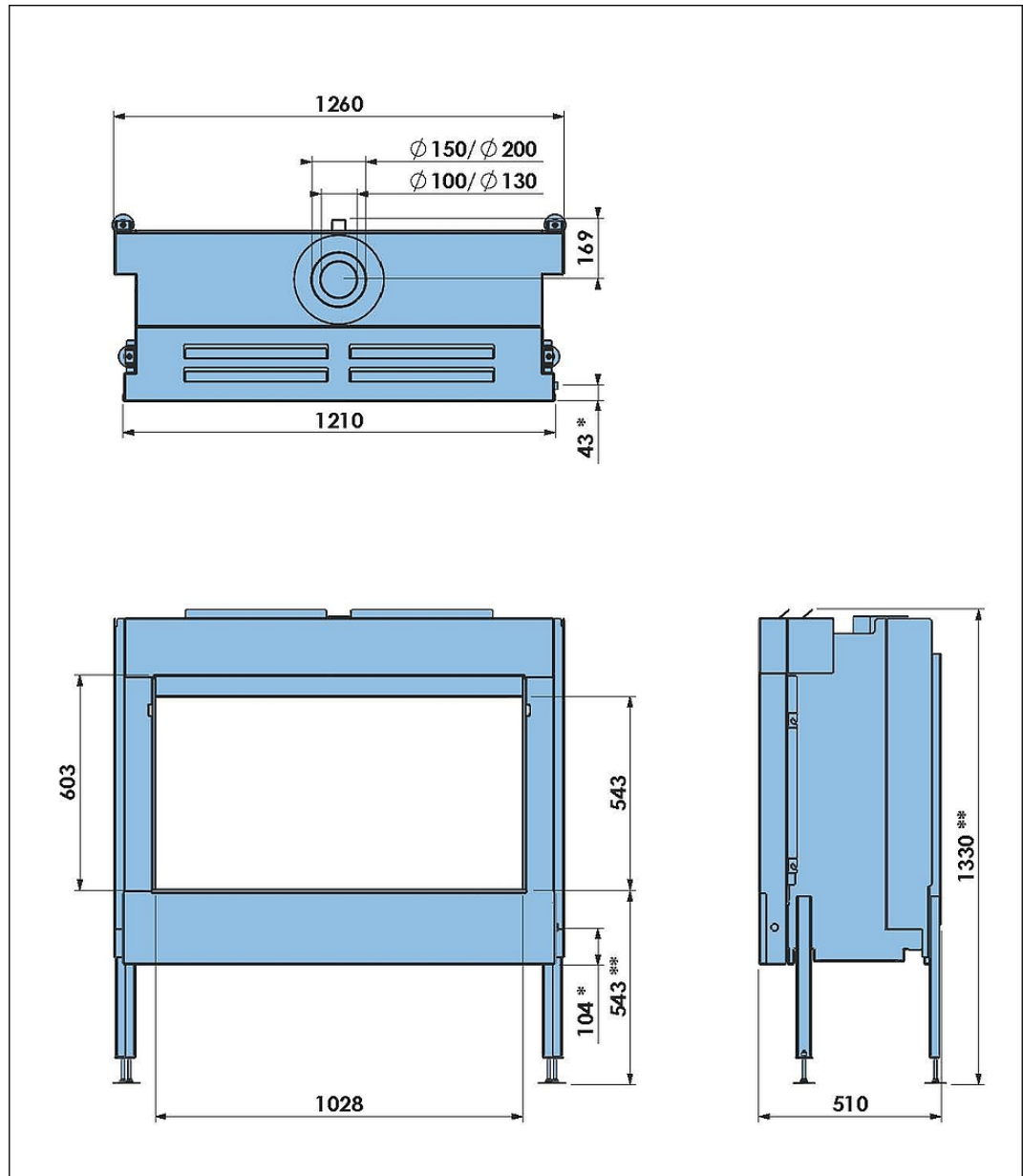
5.5 Gas Fire Front 110-60 PF2 with Hidden Door +



* = Gas connection

5.6 Gas Fire Front 110-60 PF2 with Hidden Door and adjustable legs

With optional adjustable legs

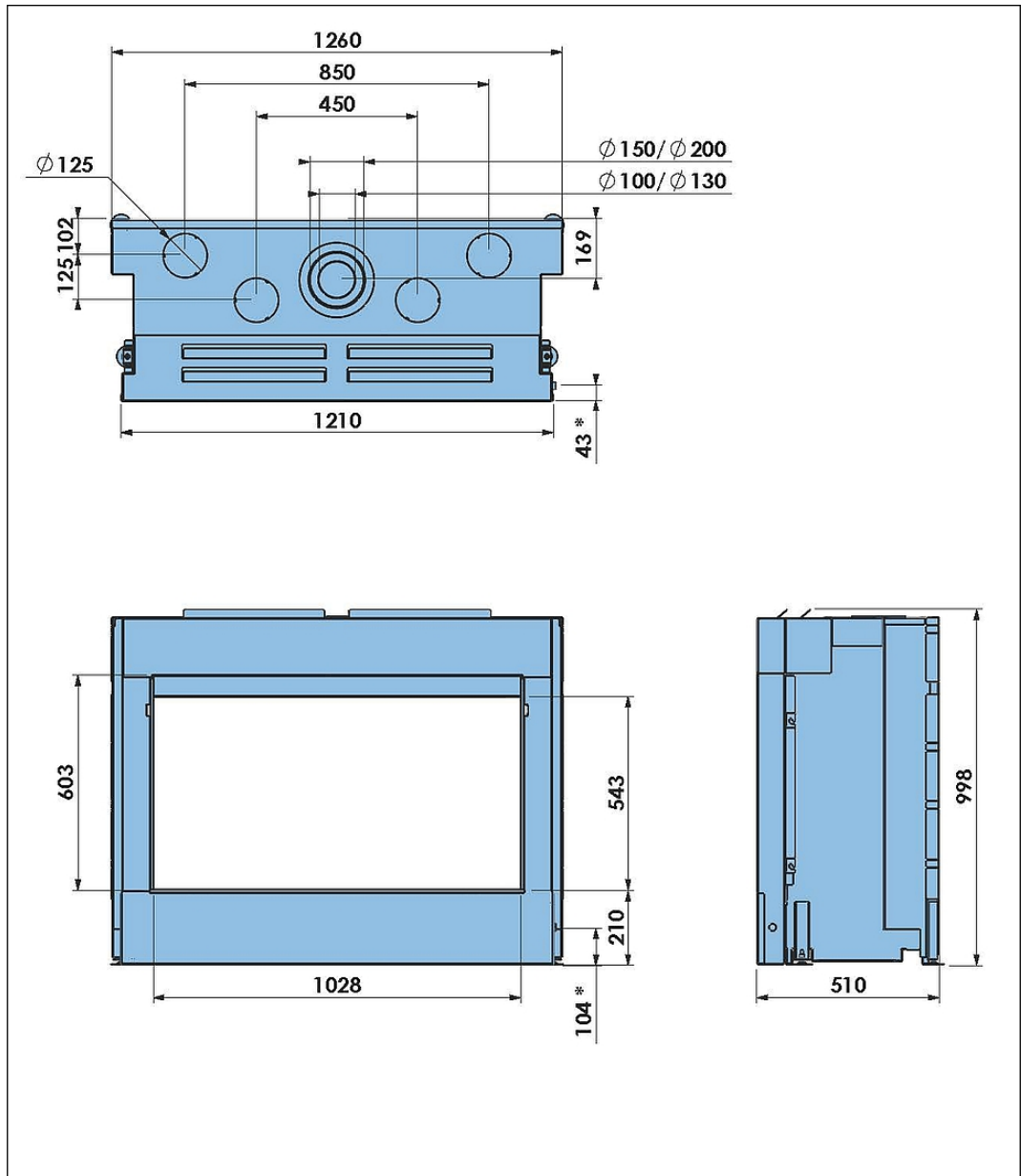


* = Gas connection

** = Maximum height with adjustable legs

5.7 Gas Fire Front 110-60 PF2 with Hidden Door and convection casing

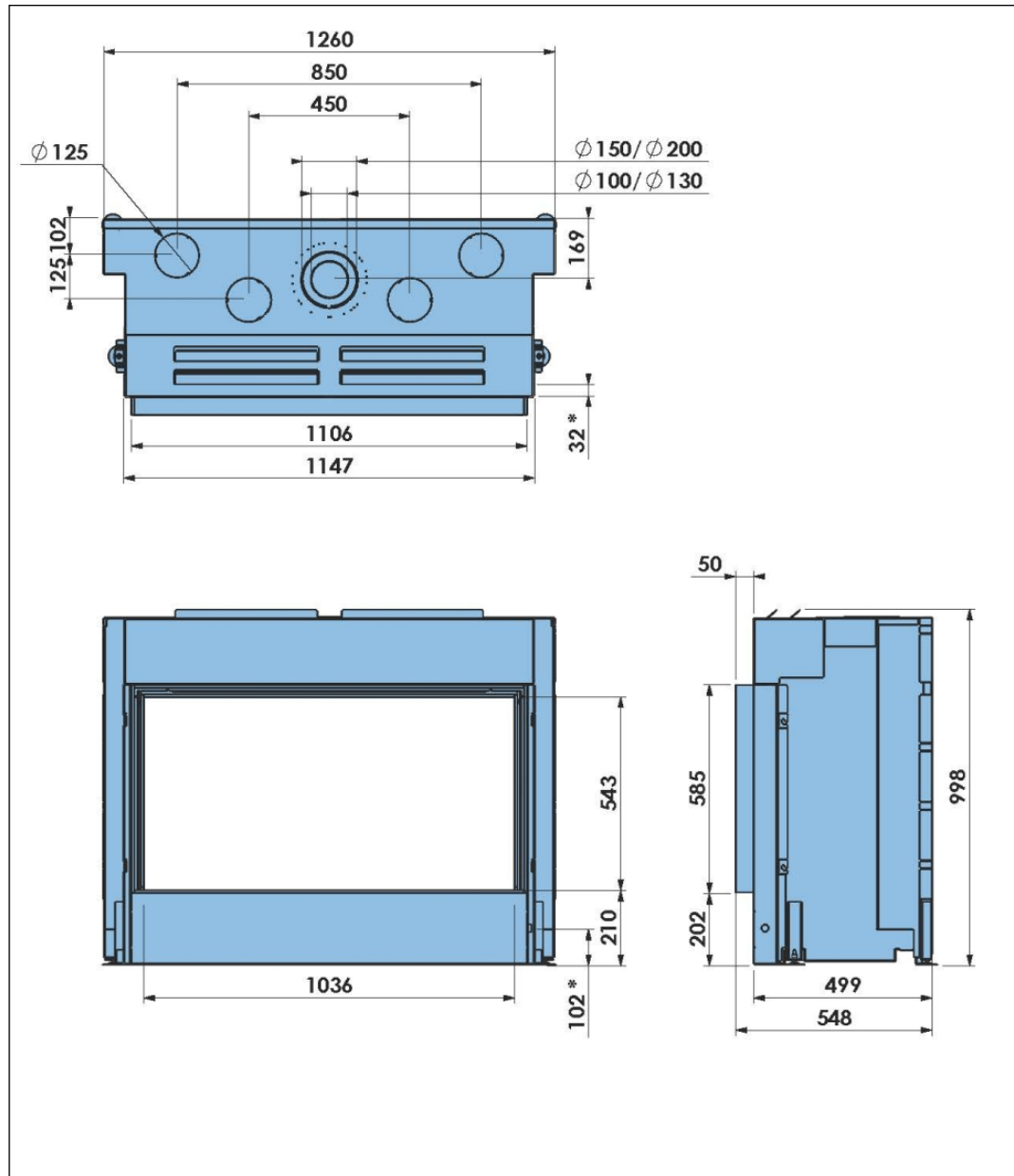
With optional convection case



* = Gas connection

5.8 Gas Fire Front 110-60 PF2 with Floating Frame + and convection casing

With optional convection case



5.9 Dimensions of the restriction plate

Width of the delivered flue restriction plates in mm	
Concentric flue connection Ø100 - Ø150	Concentric flue connection Ø130 - Ø200
Roof-mounted outlet	Horizontal wall outlet
30 mm	40 mm
40 mm	50 mm
50 mm	65 mm
65 mm	80 mm

6 Available components for the concentric flue system - natural draught



Caution:

Observe the installation instructions that are supplied with the components of the concentric flue system.

The appliance with extraction of the flue gasses by natural draught, in combination with the concentric flue system [Ø100 mm - Ø150 mm] and/or [Ø130 mm - Ø200 mm] (rigid and/or flexible) for the brand types mentioned below, has been approved in accordance with the European CE-norm for gas appliances and may therefore be used only with these systems.

Manufacturer	system
Bellfires	Muelink & Grol system
Poujoulat	DUOGAS system
Ontop	Metaloterm US system
Jeremias/STB (STB = Schoorsteen Techniek-Brummen NL)	H-Twin system
Jeremias	TWIN-GAS system
Modinox	PLA system

The permitted components for these systems are listed in this chapter. The guarantee on the appliance lapses if it is installed, fully or partially, with other components or a different flue system. The concentric flue [Ø100 mm - Ø150 mm] and [Ø130 mm - Ø200 mm] systems can be used with either a newly-built or existing chimney.

Make sure that the wall or roof termination kit that is used for the installation of the concentric flue system is also listed in the available parts list.

6.1 Appliance part list

Fig No.	Description
1	Gas fire; Concentric flue connection Ø130/Ø200 mm or Ø100/Ø150 mm.
2	-
3	-
4	Restriction plate (The different sizes restriction plates are supplied with every appliance).
5	Chimney, min. Ø150 mm internal, totally gas tight.
6	Chimney or fireproof sleeving. min. Ø160 mm internal.
7	Ø100 mm internal flexible stainless steel gas vent chimney liner AISI 316TI.
8	Ø150 mm internal flexible stainless steel gas vent chimney liner AISI 316TI.
9	-

6.2 Bellfires - Muelink & Grol system Ø100 - Ø150

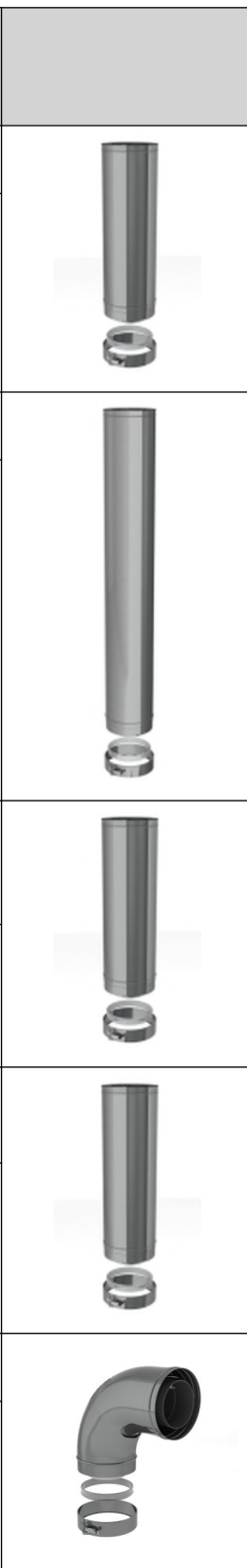

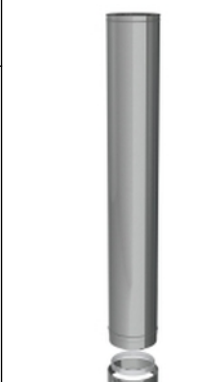



Fig. No.	Bellfires Art./ Order No.	Description		Color (*)		Application	
				stainless steel	antr.	rigid	flex
10	302289	Twin-wall balanced flue pipe. L= 500 mm.		•		•	
	346236	Twin-wall balanced flue pipe. L= 500 mm. BLACK			•	•	
11	302290	Twin-wall balanced flue pipe. L= 1000 mm.		•		•	
	346234	Twin-wall balanced flue pipe. L= 1000 mm. BLACK			•	•	
12	302291	Telescopic twin-wall balanced flue pipe, L= min. 325 / max. 440 mm.		•		•	
	346511	Telescopic twin-wall balanced flue pipe, L= min. 965 / max. 1750 mm.		•		•	
13	302292	Adjustable length twin-wall balanced flue pipe, L= 500 mm.		•		•	
	346237	Adjustable length twin-wall balanced flue pipe, L= 500 mm. BLACK			•	•	
14	302299	Twin-wall balanced flue elbow 90°. (smooth)		•		•	
	346238	Twin-wall balanced flue elbow 90°. (smooth), black			•	•	








Fig. No.	Bellfires Art./ Order No.	Description		Color (*)		Application	
				stainless steel	antr.	rigid	flex
14	302297	Twin-wall balanced flue elbow 90°. (ribbed)		•		•	
	346239	Twin-wall balanced flue elbow 90°. (segment) BLACK			•	•	
15	302298	Twin-wall balanced flue elbow 45°. (ribbed)		•		•	
	346240	Twin-wall balanced flue elbow 45°. (segment) BLACK			•	•	
	329514	Twin-wall balanced flue elbow 30°. (ribbed)		•		•	
	346507	Twin-wall balanced flue elbow 15°. (segment)		•		•	

Fig. No.	Bellfires Art./ Order No.	Description		Color (*)		Application	
				stainless steel	antr.	rigid	flex
16	302295	Vertical (roof) termination kit, L= 1360 mm. ANTHRACITE		•	•	•	•
17	302212	Adjustable roof flashing. Roof pitch 20° - 45° (**),with lead flashing.		•		•	•
18	302213	Roof flashing for existing chimney or flat roof.		•		•	•
19	302296	Horizontal (wall) termination kit, L= 600 mm (adjustable), including a set of wall spacer plates. ANTHRACITE		•	•	•	•
	346241	Horizontal (wall) termination kit, L= 600 mm (adjustable), including a set of wall spacer plates. Stainless steel. BLACK			•	•	•
	343949	Horizontal (wall) termination kit, L= 600 mm (adjustable), including a set of wall spacer plates. Stainless steel.		•		•	•
20	302293	Stainless steel locking band Ø150 mm, quick-fastening.		•		•	•
21	302210	Silicone seal Ø150 mm.				•	•

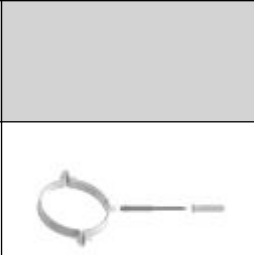

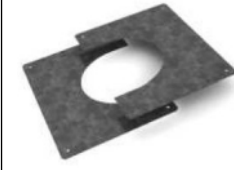

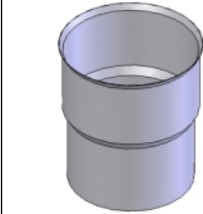
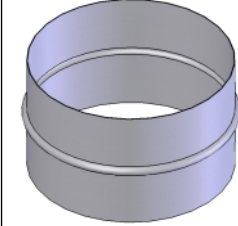

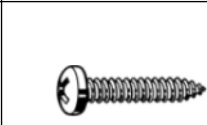







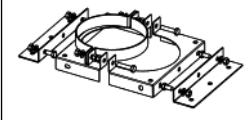
Fig. No.	Bellfires Art./ Order No.	Description		Color (*)		Application	
				stainless steel	antr.	rigid	flex
23	302215	Wall strap.		•		•	•
24	302214	Set of ceiling finishing plates / Fire stops.		•		•	•
25	302189	Ceiling plate for transition Ø100 mm / Ø150 mm rigid -Ø100 mm flex.).		•		•	•
26	302278	Stainless steel adapter piece (100) from appliance to flexible, Ø100 mm external (rigid) x Ø107 mm internal (flex.). [appliance - Ø100 mm flex.] and [Ø100 mm rigid - Ø100 mm flex.].		•			•
27	302279	Stainless steel adapter piece (150) fire to flexible, Ø148 mm external (rigid) x Ø148 mm internal (flex.) [appliance - Ø150 mm flex.].		•			•
28	302217	Stainless steel locking band Ø150 mm. For adapter 150 [appliance - Ø150 mm (flex.)], Screw-fastening.		•		•	•
29	303776	Stainless steel screws Ø3.5 mm x 9.5 mm. For securing the flexible concentric flue. (Minimum 3 screws per connection).		•			•
30	304041	Hose clamp Ø100 mm. (Minimum 2 per connection).		•			•

Fig. No.	Bellfires Art./ Order No.	Description		Color (*)		Application	
				stainless steel	antr.	rigid	flex
31	304042	Hose clamp Ø150 mm. (Minimum 2 per connection)		•			•
32	302307	Vertical (roof) termination kit, L = 610 mm. Suitable for a flexible flue system. ANTHRACITE		•	•	•	•
33	302301	Concentric T-piece with gauging orifice.		•		•	
34	302302	Concentric pipe with gauging orifice, L = 165 mm.		•		•	
35	302303	90° concentric bend with inspection panel.		•		•	
36	321948	Universal wall / floor support Ø150 mm		•		•	

(*)Color

- Stainless steel, polished
- antr. : Anthracite or Black color lacquer, matt

(**) Adjustable roof flashing for a slope > 45° can be supplied on request.

When installing a balanced-flue “closed” gas appliance in an existing chimney, ensure stainlesssteel flexible liners (Ø100 mm or Ø130 mm) conforming with EN 1856-2 are

used to extract the flue gasses. The temperature classification of the flexible pipe must be at least T450.

6.3 Bellfires - Muelink & Grol system Ø130 - Ø200






Fig. No.	Bellfires Art./ Order No.	Description		Color (*)		Application	
				stainless steel	antr.	rigid	flex
100	302319	Concentric reduction of Ø130 / Ø200 to Ø100 / Ø150		•		•	•
110	302308	Twin-wall balanced flue pipe. L= 500 mm.		•		•	
111	302309	Twin-wall balanced flue pipe. L= 1000 mm.		•		•	
112	346509	Telescopic twin-wall balanced flue pipe, L= min. 325 / max. 440 mm.		•		•	
	346512	Telescopic twin-wall balanced flue pipe, L= min. 965 / max. 1750 mm.		•		•	
113	302310	Adjustable length twin-wall balanced flue pipe, L= 500 mm.		•		•	





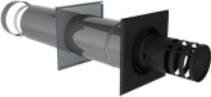

Fig. No.	Bellfires Art./ Order No.	Description		Color (*)		Application	
				stainless steel	antr.	rigid	flex
114	302314	Twin-wall balanced flue elbow 90°. (ribbed)		•		•	
115	302315	Twin-wall balanced flue elbow 45°. (ribbed)		•		•	
	346510	Twin-wall balanced flue elbow 30°. (ribbed)		•		•	
	346508	Twin-wall balanced flue elbow 15°. (segment)		•		•	
119	302313	Horizontal (wall) termination kit, L= 600 mm (adjustable), including a set of wall spacer plates. ANTHRACITE		•	•	•	
	343950	Horizontal (wall) termination kit, L= 600 mm (adjustable), including a set of wall spacer plates. Stainless steel.		•		•	
120	302311	Stainless steel locking band Ø200 mm, quick-fastening.		•		•	•


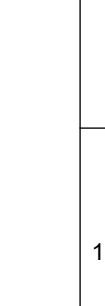

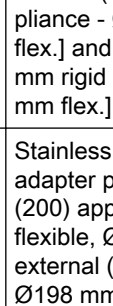
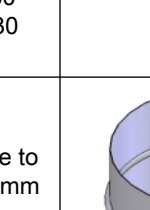






Fig. No.	Bellfires Art./ Order No.	Description		Color (*)		Application	
				stainless steel	antr.	rigid	flex
121	302248	Silicone seal Ø200 mm.				•	•
123	302251	Wall strap.				•	•
124	302250	Set of ceiling finishing plates / Fire stops.		•		•	•
126	302281	Stainless steel adapter piece (130) from appliance to flexible, Ø130 mm external (rigid) x Ø137 mm internal (flex.). [appliance - Ø130 mm flex.] and [Ø130 mm rigid - Ø130 mm flex.].		•			•
127	302282	Stainless steel adapter piece (200) appliance to flexible, Ø198 mm external (rigid) x Ø198 mm internal (flex.) [appliance - Ø200 mm flex.].		•			•
128	302257	Stainless steel locking band Ø200 mm. For adapter 200 [appliance - Ø2050 mm (flex.)], Screw-fastening.		•		•	•
129	303776	Stainless steel screws Ø3.5 mm x 9.5 mm. For securing the flexible concentric flue. (Minimum 3 screws per connection).		•			•

Fig. No.	Bellfires Art./ Order No.	Description		Color (*)		Application	
				stainless steel	antr.	rigid	flex
130	304045	Hose clamp Ø130 mm. (Minimum 2 per connection).		•			•
131	304046	Hose clamp Ø200 mm. (Minimum 2 per connection)		•			•

(*)Color

- Stainless steel, polished
- antr. : Anthracite or Black color lacquer, matt

(**) Adjustable roof flashing for a slope > 45° can be supplied on request.

When installing a balanced-flue “closed” gas appliance in an existing chimney, ensure stainlesssteel flexible liners (Ø100 mm or Ø130 mm) conforming with EN 1856-2 are used to extractthe flue gasses. The temperature classification of the flexible pipe must be at least T450.

6.4 Poujolat - DUOGAS system Ø100 - Ø150







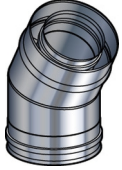

Fig No.	Poujolat Art./ Order No.	Description	
	34100403	Twin-wall balanced flue pipe, L= 250 mm.	
10	34100404	Twin-wall balanced flue pipe. L= 450 mm.	
11	34100405	Twin-wall balanced flue pipe. L= 950 mm.	
12	34100429	Telescopic twin-wall balanced flue pipe, L= min. 390 / max. 640 mm.	
14	34100441	Twin-wall balanced flue elbow 90°.	
15	34100421	Twin-wall balanced flue elbow 45°.	
15	34100411	Twin-wall balanced flue elbow 30°.	
15	34100401	Twin-wall balanced flue elbow 15°.	

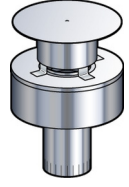
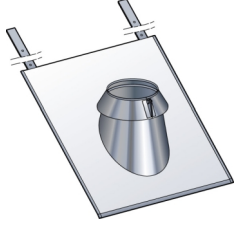
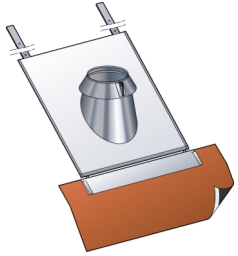
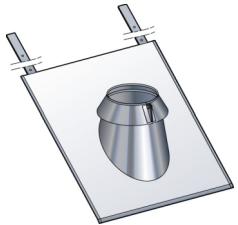
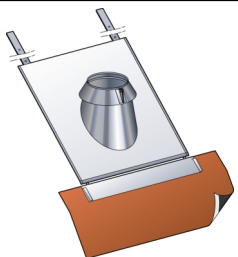
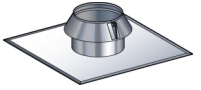
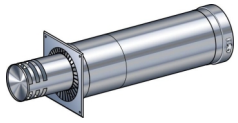

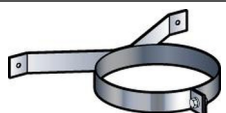
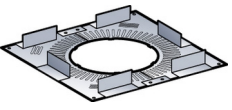




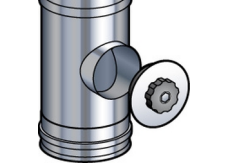
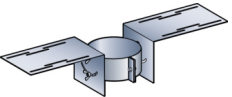
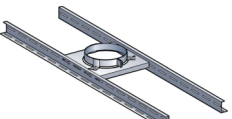
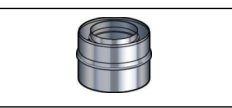


Fig No.	Poujolat Art./ Order No.	Description	
16	34100654	Vertical (roof) termination kit, L= 140 mm .	
17	45150171	Roof flashing, suitable for a brick roof, with a roof pitch of 15°- 30°.	
17	45150170	Roof flashing, suitable for a tiled roof, with a roof pitch of 15°- 30°.	
17	45150172	Roof flashing, suitable for a brick roof, with a roof pitch of 30°- 45°.	
17	45150173	Roof flashing, suitable for a tiled roof, with a roof pitch of 30°- 45°.	
18	45150169	Roof flashing for existing chimney or flat roof.	
19	34100610	Horizontal (wall) termination kit, L= min. 365 mm / max. 585 mm.	
20	45150076	Stainless steel locking band Ø150 mm, quick-fastening.	
23	45150072	Wall strap, Ø150 mm.	

Fig No.	Poujoulat Art./ Order No.	Description	
24	37100442	Ceiling/wall plate with spacers and ventilation grooves.	
24	37100425	Set of ceiling finishing plates / Fire stops, suitable for a roof pitch of 0°- 10°.	
24	37100426	Set of ceiling finishing plates / Fire stops, suitable for a roof pitch of 10°- 30°.	
24	37100427	Set of ceiling finishing plates / Fire stops, suitable for a roof pitch of 30°- 40°.	
24	37100428	Set of ceiling finishing plates / Fire stops, suitable for a roof pitch of 40°- 50°.	
34	34100407	Concentric pipe with inspection opening, L= 250 mm.	
36	45150165	Roof support, (universal) Ø150 mm.	
36	45150081	Floor support, (universal) Ø150 mm.	
37	34100611	Adapter: Bellfires Ø100-150 mm → Poujoulat DUOGAS Ø100-150 mm (Appliance 100/150 → Poujoulat DUOGAS 100/150)	
100	34100614	Adapter: Bellfires Ø130-200 mm → Poujoulat DUOGAS Ø100-150 mm (Appliance 130/200 → Poujoulat DUOGAS 100/150)	
101	34100613	Concentric reduction of Poujoulat DUOGAS Ø130-200 mm → Poujoulat DUOGAS Ø100-150 mm	

6.5

Poujoulat - DUOGAS system Ø130 - Ø200







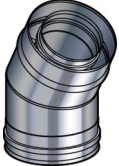

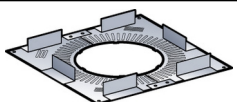

Fig No.	Poujoulat Art./ Order No.	Description	
	34130403	Twin-wall balanced flue pipe, L= 250 mm.	
110	34130404	Twin-wall balanced flue pipe. L= 450 mm.	
111	34130405	Twin-wall balanced flue pipe. L= 950 mm.	
112	34130429	Telescopic twin-wall balanced flue pipe, L= min. 390 / max. 640 mm.	
114	34130441	Twin-wall balanced flue elbow 90°.	
115	34130421	Twin-wall balanced flue elbow 45°.	
115	34130411	Twin-wall balanced flue elbow 30°.	
115	34130401	Twin-wall balanced flue elbow 15°.	

Fig No.	Poujoulat Art./ Order No.	Description	
119	34130610	Horizontal (wall) termination kit, L= min. 365 mm / max. 585 mm.	
120	45200076	Stainless steel locking band Ø200 mm, quick-fastening.	
123	45200072	Wall strap, Ø200 mm.	
124	37130442	Ceiling/wall plate with spacers and ventilation grooves.	
124	37130425	Set of ceiling finishing plates / Fire stops, suitable for a roof pitch of 0° - 10°.	
	37130426	Set of ceiling finishing plates / Fire stops, suitable for a roof pitch of 10° - 30°.	
	37130427	Set of ceiling finishing plates / Fire stops, suitable for a roof pitch of 30° - 40°.	
	37130428	Set of ceiling finishing plates / Fire stops, suitable for a roof pitch of 40° - 50°.	
134	34130407	Concentric pipe with inspection opening, L= 250 mm.	
136	45200165	Roof support, (universal) Ø200 mm.	
136	45200081	Floor support, (universal) Ø200 mm.	
137	34130615	Adapter: Bellfires Ø130-200 mm → Poujoulat DUOGAS Ø130-200 mm (Appliance 1300/200 → Poujoulat DUOGAS 130/200)	

6.6

Ontop - Metaloterm US system Ø100 - Ø150

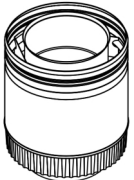
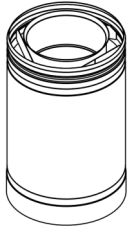
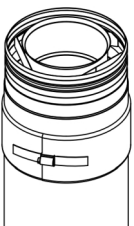
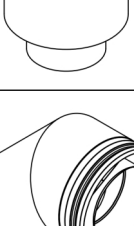
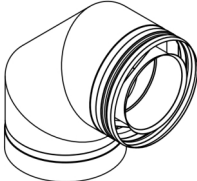
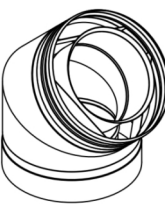
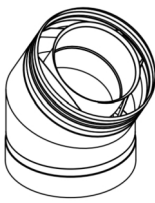
Fig. No.	Ontop Art. / Order No.	Description	
	USA 10	Adapter for Bellfires appliances with Ø100-Ø150 mm concentric connection.	
	US 25 10	Twin-wall balanced flue pipe, L = 250 mm.	
10	US 50 10	Twin-wall balanced flue pipe. L= 500 mm.	
11	US 100 10	Twin-wall balanced flue pipe. L= 1000 mm.	
12	USPP 10	Telescopic twin-wall balanced flue pipe, L= min. 60 / max. 250 mm.	
14	USB 90 10	Twin-wall balanced flue elbow 90°.	
15	USB 45 10	Twin-wall balanced flue elbow 45°.	
15	USB 30 10	Twin-wall balanced flue elbow 30°.	

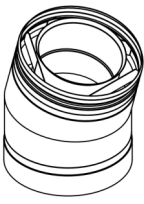
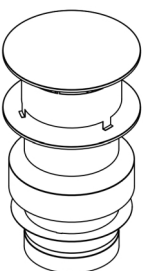

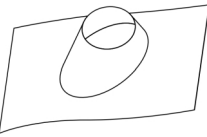
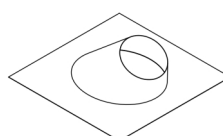
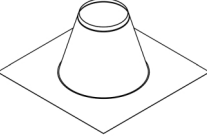
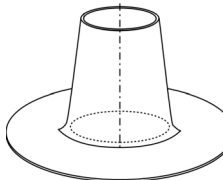
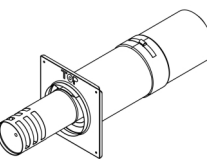

Fig. No.	Ontop Art. / Order No.	Description	
15	USB 15 10	Twin-wall balanced flue elbow 15°.	
16	USDVC2 10	Vertical (roof) termination kit, L= 375 mm.	
16	USSR 10	Storm collar Ø150 mm.	
17	USLS 10	Adjustable roof flashing. Roof pitch 20° - 45°, with lead flashing.	
17	USDH 10	Roof flashing plate for roof pitch 5° - 30°.	
18	USDP 10	Roof flashing for existing chimney or flat roof.	
18	USDPAL 10	Roof flashing - Aluminum - For existing chimney or flat roof.	
19	USDHC5 10	Horizontal (wall) termination kit, L= 475 mm (adjustable).	
20	USKB 10	Locking band, quick-fastening.	

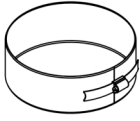
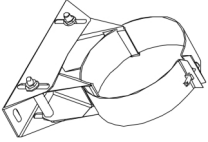
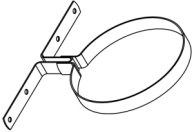
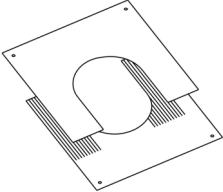
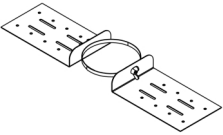
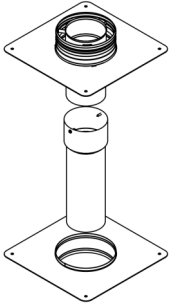
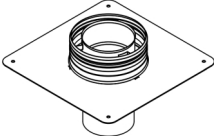
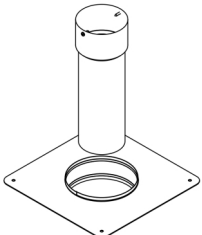

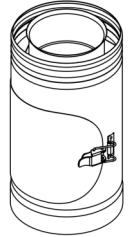

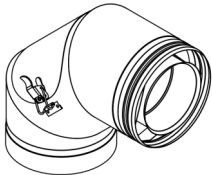
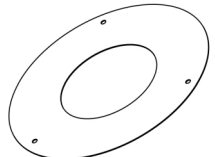
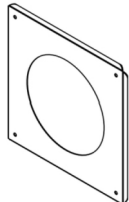
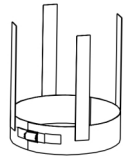

Fig. No.	Ontop Art. / Order No.	Description	
21	USAB 10	Cover band, screw-fastening.	
23	USMB 10	Wall strap, adjustable.	
23	USEB 10	Fitting bracket.	
24	USCP 10	Set of ceiling finishing plates / Fire stops /Centering plates.	
24	USDQ 10	Roof support.	
25	USSAN 10	Renovation set.	
25	USSAN1 10	Top of renovation set.	
25	USSAN2 10	Bottom renovation set.	

Fig. No.	Ontop Art. / Order No.	Description	
28	USKBS 10	Locking band, screw-fastening.	
	USI 10	Concentric pipe with inspection panel, L= 250 mm.	
34	USEM 10	Concentric pipe with gauging orifice, L= 150 mm.	
35	USBI 10	90° concentric bend with inspection panel.	
	USR 10	Rosette smooth Ø150 mm.	
	USMPG 10	Wall plate large Ø150 mm, square 300 mm.	
	USAH 10	Spacer bracket.	
	USVG 10 13	Concentric reduction of Ø100-Ø150 mm → Ø130-Ø200 mm.	

6.7

Ontop - Metaloterm US system Ø130 - Ø200

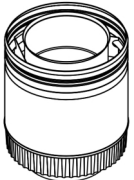
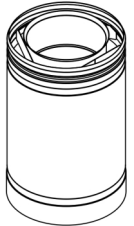
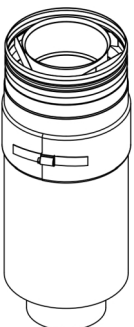
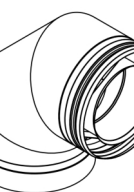
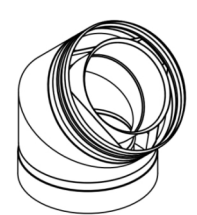
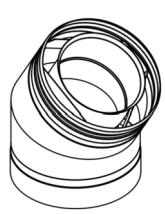
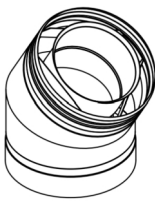
Fig. No.	Ontop Art. / Order No.	Description	
	USA 13	Adapter for Bellfires appliances with Ø100-Ø150 mm concentric connection.	
	US 25 13	Twin-wall balanced flue pipe, L = 250 mm.	
110	US 50 13	Twin-wall balanced flue pipe. L= 500 mm.	
111	US 100 13	Twin-wall balanced flue pipe. L= 1000 mm.	
112	USPP 13	Telescopic twin-wall balanced flue pipe, L= min. 60 / max. 250 mm.	
114	USB 90 13	Twin-wall balanced flue elbow 90°.	
115	USB 45 13	Twin-wall balanced flue elbow 45°.	
115	USB 30 13	Twin-wall balanced flue elbow 30°.	

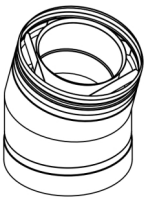
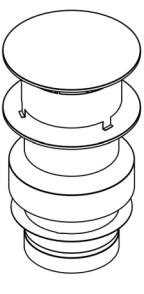
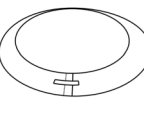
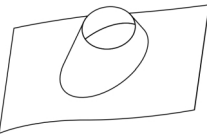
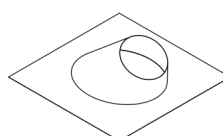
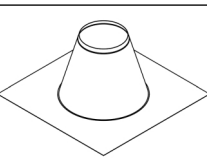
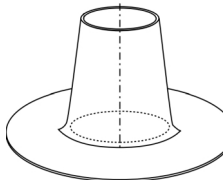
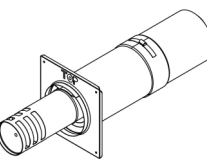

Fig. No.	Ontop Art. / Order No.	Description	
115	USB 15 13	Twin-wall balanced flue elbow 15°.	
116	USDVC2 13	Vertical (roof) termination kit, L= 375 mm.	
116	USSR 13	Storm collar Ø150 mm.	
117	USLS 13	Adjustable roof flashing. Roof pitch 20° - 45°, with lead flashing.	
117	USDH 13	Roof flashing plate for roof pitch 5° - 30°.	
118	USDP 13	Roof flashing for existing chimney or flat roof.	
118	USDPAL 13	Roof flashing - Aluminum - For existing chimney or flat roof.	
119	USDHC4 13	Horizontal (wall) termination kit, L= 475 mm (adjustable).	
120	USKB 13	Locking band, quick-fastening.	

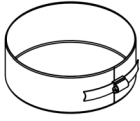
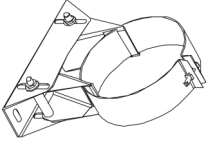
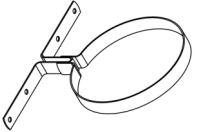
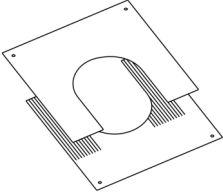
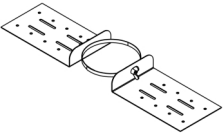
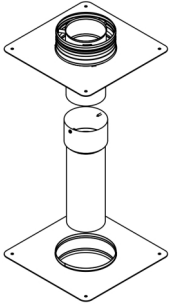
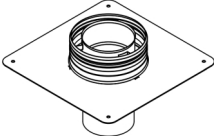
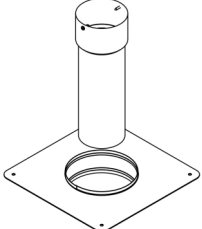
Fig. No.	Ontop Art. / Order No.	Description	
121	USAB 13	Cover band, screw-fastening.	
123	USMB 13	Wall strap, adjustable.	
123	USEB 13	Fitting bracket.	
124	USCP 13	Set of ceiling finishing plates / Fire stops /Centering plates.	
124	USDQ 13	Roof support.	
125	USSAN 13	Renovation set.	
125	USSAN1 13	Top of renovation set.	
125	USSAN1 13	Bottom renovation set.	

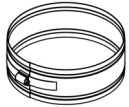
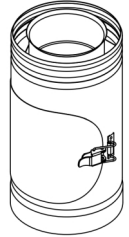

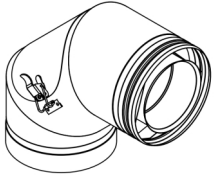
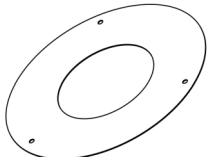
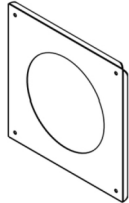
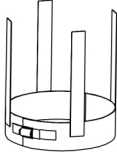

Fig. No.	Ontop Art. / Order No.	Description	
128	USKBS 13	Locking band, screw-fastening.	
	USI 13	Concentric pipe with inspection panel, L= 250 mm.	
134	USEM 13	Concentric pipe with gauging orifice, L= 150 mm.	
135	USBI 13	90° concentric bend with inspection panel.	
	USR 13	Rosette smooth Ø200 mm.	
	USMPG 13	Wall plate large Ø200 mm, square 350 mm.	

Fig. No.	Ontop Art. / Order No.	Description	
	USAH 13	Spacer bracket.	
	USVG 13 10	Concentric reduction of Ø130-Ø200 mm → Ø100-Ø150 mm.	

6.8 Jeremias/STB - H-Twin system Ø100 - Ø150






Fig. No.	Jeremias Art. / Order No.	Description	
11	ATWINL 13100-150	Twin-wall balanced flue pipe. L= 1000 mm.	
10	ATWINL 14100-150	Twin-wall balanced flue pipe. L= 500 mm.	
10	ATWINL 15100-150	Twin-wall balanced flue pipe. L= 250 mm.	
12	H-TWIN 742100-150	Telescopic twin-wall balanced flue pipe, L= min. 1100 / max. 1400 mm.	
12	H-TWIN 467100-150	Telescopic twin-wall balanced flue pipe, L= min. 1100 / max. 1900 mm.	
12	ATWIN 197100-150	Telescopic twin-wall balanced flue pipe, L= min. 600 / max. 900 mm.	
15	ATWIN 16 100-150	Twin-wall balanced flue elbow 15°.	









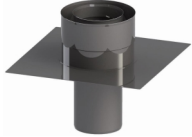
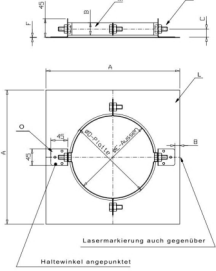

Fig. No.	Jeremias Art. / Order No.	Description	
15	ATWIN 17 100-150	Twin-wall balanced flue elbow 30°.	
15	ATWIN 18 100-150	Twin-wall balanced flue elbow 45°.	
14	ATWIN 60100-150	Twin-wall balanced flue elbow 90°.	
14	ATWIN 60F100-150	Twin-wall balanced flue elbow 90° - Short. Especially for connection to a wall termination.	
16	A 463100-150	Roof termination - long, with pipe, L = 1080 mm, Vertical.	

Fig. No.	Jeremias Art. / Order No.	Description	
16	ATWIN 92100-150	Roof termination - short with pipe, L = 300 mm, Vertical.	
32	ATWIN 92pe100-150 0	Roof termination, with pipe, L = 495 mm, Vertical, with roof flashing for existing chimney or flat roof.	
17	ATWIN 45DD 100-150	Roof flashing for roof pitch 30°, with lead flashing and storm collar.	
17	ATWIN 60DD 100-150	Roof flashing for roof pitch 45°, with lead flashing and storm collar.	
	ATWIN 307 100-150	Storm collar.	
24	ADBL- DW100-150	Set of ceiling finishing plates / Fire stops.	
20	ATWIN 45100-150	Locking band, Screw-fastening (Standard on all components).	
23	ATWIN 22100-150	Wall strap, adjustable.	
23	ATWIN 23100-150	Wall strap, distance adjustable 60-250 mm.	

Fig. No.	Jeremias Art. / Order No.	Description	
19	A681100-150	Horizontal (wall) termination kit, L= 495 mm (horizontally adjustable), including one set of wall spacer plates.	
33	H-TWIN 752100-150	Concentric T-piece with gauging orifice. Inspection panel with cover cap and condensation-opening.	
	ATWIN 465 100-150	Adapter: H-TWIN Ø100-150 → Flex Stainless steel ; Ø100 mm Incl. Ceiling plate 300x300 mm.	
	ATWIN 466100-150	Adapter: Flex Stainless steel; Ø100 mm → H-TWIN Ø100-150 Incl. Chimney(ceiling)plate 300x300 mm.	
36	ASDH2 100-150	Universal wall / floor support Ø150 mm.	
100	A464 130	Concentric reduction of H-TWIN Ø130 / Ø200 mm → H-TWIN Ø100 / Ø150 mm.	

6.9 Jeremias/STB - H-Twin system Ø130 - Ø200






Fig. No.	Jeremias Art. / Order No.	Description	
111	ATWINL 13130-200	Twin-wall balanced flue pipe. L= 1000 mm.	
110	ATWINL 14130-200	Twin-wall balanced flue pipe. L= 500 mm.	
110	ATWINL 15130-200	Twin-wall balanced flue pipe. L= 250 mm.	
112	H-TWIN 742130-200	Telescopic twin-wall balanced flue pipe, L= min. 1100 / max. 1400 mm.	
112	H-TWIN 467130-200	Telescopic twin-wall balanced flue pipe, L= min. 1100 / max. 1900 mm.	
112	ATWIN 197130-200	Telescopic twin-wall balanced flue pipe, L= min. 600 / max. 900 mm.	
115	ATWIN 16 130-200	Twin-wall balanced flue elbow 15°.	












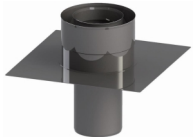
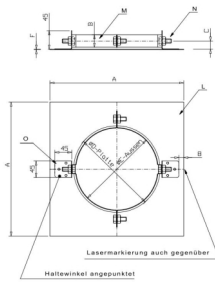

Fig. No.	Jeremias Art. / Order No.	Description	
115	ATWIN 17 130-200	Twin-wall balanced flue elbow 30°.	
115	ATWIN 18 130-200	Twin-wall balanced flue elbow 45°.	
114	ATWIN 60130-200	Twin-wall balanced flue elbow 90°.	
114	ATWIN 60F130-200	Twin-wall balanced flue elbow 90° - Short. Especially for connection to a wall termination.	
124	ADBL- DW130-200	Set of ceiling finishing plates / Fire stops.	
120	ATWIN 45130-200	Locking band, Screw-fastening (Standard on all components).	
123	ATWIN 22130-200	Wall strap, adjustable.	
123	ATWIN 23130-200	Wall strap, distance adjustable 60-250 mm.	
119	A681130-20 0	Horizontal (wall) termination kit, L= 495 mm (horizontally adjustable), including one set of wall spacer plates.	

Fig. No.	Jeremias Art. / Order No.	Description	
133	H-TWIN 752130-200	Concentric T-piece with gauging orifice. Inspection panel with cover cap and condensation-opening.	
	ATWIN 465 130-200	Adapter: H-TWIN Ø130-200 → Flex Stainless steel ; Ø130 mm Incl. Ceiling plate 300x300 mm.	
	ATWIN 466130-200	Adapter: Flex Stainless steel; Ø130 mm → H-TWIN Ø130-200 Incl. Chimney(ceiling)plate 300x300 mm.	
136	ASDH2 130-200	Universal wall / floor support Ø200 mm.	
100	A464 130	Concentric reduction of H-TWIN Ø130 / Ø200 mm → H-TWIN Ø100 / Ø150 mm.	

6.10

Jeremias - TWIN-GAS system Ø100 - Ø150






Fig. No.	Jeremias Art. / Order No.	Description	
	TWG163410-150	Bellfires Appliance connection / AdapterBellfires Ø100/150 mm → Jeremias TWIN-GAS Ø100/150 mm L = 160 mm Including locking band (2x).	
11	TWG13100-150	Twin-wall balanced flue pipe, L = 1000 mm Including locking band.	
10	TWG14100-150	Twin-wall balanced flue pipe, L = 500 mm Including locking band.	
10	TWG15100-150	Twin-wall balanced flue pipe, L = 250 mm Including locking band.	
	TWG180110-150	Twin-wall balanced flue pipe, L = 1000 mm with 4 spacer brackets on the outside Including locking band.	








Fig. No.	Jeremias Art. / Order No.	Description	
12	TWG50100-150	Telescopic twin-wall balanced flue pipe, L= min. 330 / max. 420 mm Including locking band.	
15	TWG16100-150	Twin-wall balanced flue elbow 15°. Including locking band.	
15	TWG17100-150	Twin-wall balanced flue elbow 30°. Including locking band.	
15	TWG18100-150	Twin-wall balanced flue elbow 45°. Including locking band.	
14	TWG60100-150	Twin-wall balanced flue elbow 90°. Including locking band.	
14	TWG178610-0-150	Twin-wall balanced flue elbow 90° - with support leg Including locking band and sealing cap under.	
14	TWG167610-0-150	Twin-wall balanced flue elbow 90° - short - eccentric. Especially for connection to a wall termination TWG1619 Including locking band.	


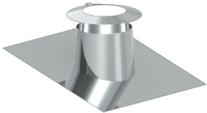
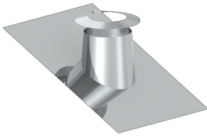



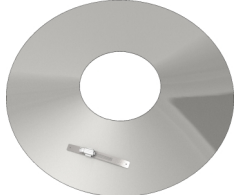
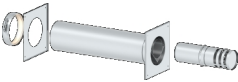
Fig. No.	Jeremias Art. / Order No.	Description	
16	TWG272100-150	Roof termination (vertical) L= 615 mm. Including locking band.	
17	TW53150	Roof flashing with a roof pitch of 5° - 15° with flex. alu-flashing and storm collar.	
17	TW59 150	Roof flashing with a roof pitch of 16° - 25° with flex. alu-flashing and storm collar.	
17	TW38 150	Roof flashing with a roof pitch of 26° - 35° with flex. alu-flashing and storm collar.	
17	TW54 150	Roof flashing with a roof pitch of 36° - 45° with flex. alu-flashing and storm collar.	
18	TW52150	Roof flashing for existing chimney or flat roof with storm collar.	
	KL72150	Storm collar (spare part).	
19	TWG161910 0-150	Wall termination kit, L= 600 mm (horizontal) Adjustable. Incl. locking band and one set of wall spacer plates.	







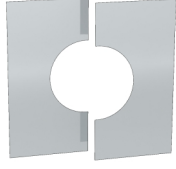

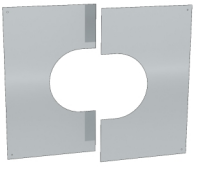
Fig. No.	Jeremias Art. / Order No.	Description	
20	TW45150	Locking band, screw-fastening(spare part).	
21	ALBI26150	Silicone sealing ring for outer pipe(spare part).	
23	ZU-WA704150	Wall strap. Distance to the wall: WA= 50 mm.	
	ZU-WA891130	Extension pieces for the wall strap ZUWA704L= 130 mm.	
	ZU-WA891200	Extension pieces for the wall strap ZUWA704L= 200 mm.	
	ZU-WA891250	Extension pieces for the wall strap ZUWA704L= 250 mm.	
	ZUWA706	Extension pieces for the wall strap ZUWA704L= 400 mm, WA = 50 - 360 mm.	
24	ZU-DA074150	Set of ceiling finishing plates / Fire stopsfor a flat roof : 0°.	
24	ZU-DA99V150	Set of ceiling finishing plates / Fire stopsfor a pitched roof : 0° - 30°.	
24	ZU-DA98V150	Set of ceiling finishing plates / Fire stopsfor a pitched roof : 31° - 45°.	
















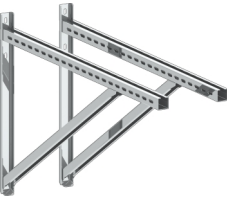
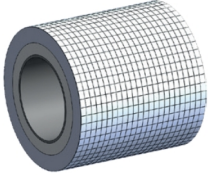
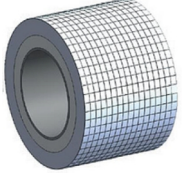
Fig. No.	Jeremias Art. / Order No.	Description	
24	ZU-DA99VHL150	Set of ceiling finishing plates / Fire stops with ventilation openings for a pitched roof : 0° - 30°.	
24	ZU-DA98VHL150	Set of ceiling finishing plates / Fire stops with ventilation openings for a pitched roof : 31° - 45°.	
25	FD08 100	Adapter: TWIN-GAS to FLEX. (only for the inner pipe Ø100 mm).	
25	TWG1276D 100-150	Chimney-/flat roof-/ceiling - plate with adapter: FLEX to TWIN-GAS.	
25	ZU-WA1618100	Adapter: TWIN-GAS to 'Schaff' (DE).	
25	TWG173210 0-150	Chimney-/flat roof-/ceiling - plate with adapter: Ø100 rigid/flex. to TWIN-GAS .	
33	TWG317100-150	Concentric T-piece 90°. Including locking band.	
34	TWG51100-150	Concentric pipe with gauging orifice L= 200 mm. Including locking band.	
35	TWG10 100-150	Concentric pipe, L= 300 mm with cleaning opening/inspection panel. Including locking band.	
35	TWG19100-150	Concentric elbow 90° with cleaning opening/inspection panel. Including locking band.	
36	TWG05100-150	Base plate/Cover-under with 2x ½" gauging orifice, sealing cap and condensate drain at the bottom.	

Fig. No.	Jeremias Art. / Order No.	Description	
36	TWG07100-150	Base plate / floor support.	
	DW391	Wall support with transverse supportType I: 350 mm - Distance to wall: WA= max. 50 mm.	
	DW392	Wall support with transverse supportType II: 500 mm - Distance to wall: WA= 50 - 150 mm.	
	DW393	Wall support with transverse supportType III: 750 mm - Distance to wall: WA= 150 - 250 mm.	
	DW407	Wall support with transverse supportType IV: 1030 mm - Distance to wall: WA= 250 - 360 mm.	
(17-24)	LUX-ECO150	Insulation roof flashing, L= Max. 500 mm (adjustable). Wall thickness LUX-ECO Insulation: min. 25 mm.	
(19)	LUX-ECO150	Insulation wall flashing, L= Max. 360 mm(adjustable). Wall thickness LUX-ECO Insulation: min. 25 mm.	

6.11

Jeremias - TWIN-GAS system Ø130 - Ø200






Fig. No.	Jeremias Art. / Order No.	Description	
	TWG1634130-200	Bellfires Appliance connection / AdapterBellfires Ø130/200 mm → Jeremias TWIN-GAS Ø130/200 mmL = 160 mmIncluding locking band (2x).	
111	TWG13130-200	Twin-wall balanced flue pipe, L = 1000 mmIncluding locking band.	
110	TWG14130-200	Twin-wall balanced flue pipe, L = 500 mmIncluding locking band.	
110	TWG15130-200	Twin-wall balanced flue pipe, L = 250 mmIncluding locking band.	
	TWG1801130-200	Twin-wall balanced flue pipe, L = 1000 mmwith 4 spacer brackets on the outsideIncluding locking band.	








Fig. No.	Jeremias Art. / Order No.	Description	
112	TWG50130-200	Telescopic twin-wall balanced flue pipe, L= min. 330 / max. 420 mm Including locking band.	
115	TWG16130-200	Twin-wall balanced flue elbow 15°. Including locking band.	
115	TWG17130-200	Twin-wall balanced flue elbow 30°. Including locking band.	
115	TWG18130-200	Twin-wall balanced flue elbow 45°. Including locking band.	
114	TWG60130-200	Twin-wall balanced flue elbow 90°. Including locking band.	
114	TWG1786130-200	Twin-wall balanced flue elbow 90° - with support leg Including locking band and sealing cap under.	
114	TWG1676130-200	Twin-wall balanced flue elbow 90° - short - eccentric. Especially for connection to a wall termination TWG1619 Including locking band.	


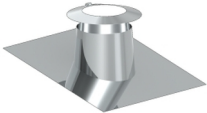
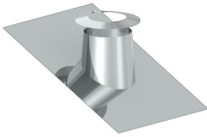
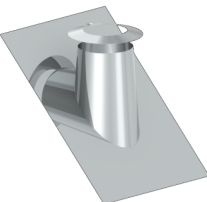
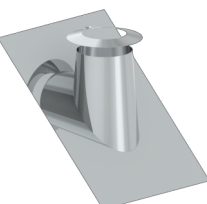


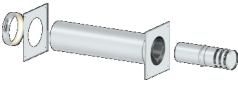
Fig. No.	Jeremias Art. / Order No.	Description	
116	TWG272130-200	Roof termination (vertical) L= 615 mm. Including locking band.	
117	TW53200	Roof flashing with a roof pitch of 5° - 15° with flex. alu-flashing and storm collar.	
117	TW59 200	Roof flashing with a roof pitch of 16° - 25° with flex. alu-flashing and storm collar.	
117	TW38 200	Roof flashing with a roof pitch of 26° - 35° with flex. alu-flashing and storm collar.	
117	TW54 200	Roof flashing with a roof pitch of 36° - 45° with flex. alu-flashing and storm collar.	
118	TW52200	Roof flashing for existing chimney or flat roof with storm collar.	
	KL72200	Storm collar (spare part).	
119	TWG161913 0-200	Wall termination kit, L= 600 mm (horizontal) Adjustable. Incl. locking band and one set of wall spacer plates.	

Fig. No.	Jeremias Art. / Order No.	Description	
120	TW45200	Locking band, screw-fastening(spare part).	
121	ALBI26200	Silicone sealing ring for outer pipe(spare part).	
123	ZU-WA704200	Wall strap. Distance to the wall: WA= 50 mm.	
	ZU-WA891130	Extension pieces for the wall strap ZUWA704L= 130 mm.	
	ZU-WA891200	Extension pieces for the wall strap ZUWA704L= 200 mm.	
	ZU-WA891250	Extension pieces for the wall strap ZUWA704L= 250 mm.	
	ZUWA706	Extension pieces for the wall strap ZUWA704L= 400 mm, WA = 50 - 360 mm.	
124	ZU-DA074200	Set of ceiling finishing plates / Fire stopsfor a flat roof : 0°.	
124	ZU-DA99V200	Set of ceiling finishing plates / Fire stopsfor a pitched roof : 0° - 30°.	
124	ZU-DA98V200	Set of ceiling finishing plates / Fire stopsfor a pitched roof : 31° - 45°.	
















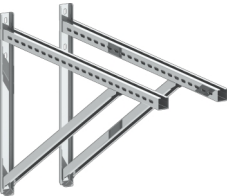

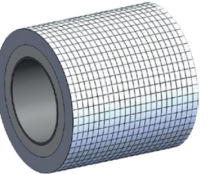
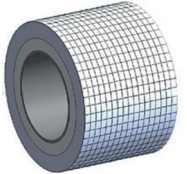
Fig. No.	Jeremias Art. / Order No.	Description	
124	ZU-DA99VHL200	Set of ceiling finishing plates / Fire stops with ventilation openings for a pitched roof : 0° - 30°.	
124	ZU-DA98VHL200	Set of ceiling finishing plates / Fire stops with ventilation openings for a pitched roof : 31° - 45°.	
125	FD08 130	Adapter: TWIN-GAS to FLEX. (only for the inner pipe Ø100 mm).	
125	TWG1276D 130-200	Chimney-/flat roof-/ceiling - plate with adapter: FLEX to TWIN-GAS.	
125	ZU-WA1618130	Adapter: TWIN-GAS to 'Schaff' (DE).	
125	TWG1732130-200	Chimney-/flat roof-/ceiling - plate with adapter: Ø100 rigid/flex. to TWIN-GAS .	
133	TWG317130-200	Concentric T-piece 90°. Including locking band.	
134	TWG51130-200	Concentric pipe with gauging orifice L= 200 mm. Including locking band.	
135	TWG10 130-200	Concentric pipe, L= 300 mm with cleaning opening/inspection panel. Including locking band.	
135	TWG19130-200	Concentric elbow 90° with cleaning opening/inspection panel. Including locking band.	
136	TWG05130-200	Base plate/Cover-under with 2x ½" gauging orifice, sealing cap and condensate drain at the bottom.	

Fig. No.	Jeremias Art. / Order No.	Description	
136	TWG07130-200	Base plate / floor support.	
	DW391	Wall support with transverse supportType I: 350 mm - Distance to wall: WA= max. 50 mm.	
	DW392	Wall support with transverse supportType II: 500 mm - Distance to wall: WA= 50 - 150 mm.	
	DW393	Wall support with transverse supportType III: 750 mm - Distance to wall: WA= 150 - 250 mm.	
	DW407	Wall support with transverse supportType IV: 1030 mm - Distance to wall: WA= 250 - 360 mm.	
100	TWGR	Concentric reduction Jeremias TWIN-GAS Ø130/Ø200 → Jeremias TWIN-GAS Ø100/Ø150	
	LUX-ECO200	Insulation roof flashing, L= Max. 500 mm (adjustable). Wall thickness LUX-ECO Insulation: min. 25 mm.	
(11 9)	LUX-ECO200	Insulation wall flashing, L= Max. 360 mm(adjustable). Wall thickness LUX-ECO Insulation: min. 25 mm.	

6.12 Modinox - PLA system Ø100 - Ø153


Fig. No.	Modinox Art./ Order No.	Description		Color (*)		Application	
				stainless steel	antr.	rigid	flex
	2PLAMAFM100BEL	Bellfires appliance connection: Adapter Bellfires Ø100/150 mm → Modinox PLA Ø100/153 mm. L= 230 mm. INOX		•		•	
	2PLAMAFM100BELNO	Bellfires appliance connection: Adapter Bellfires Ø100/150 mm → Modinox PLA Ø100/153 mm. L= 230 mm. INOX - BLACK			•	•	
10	2PLAELDR100250	Twin-wall balanced flue pipe, L= 250 mm., INOX		•		•	
	2PLAELDR100250NO	Twin-wall balanced flue pipe, L= 250 mm., INOX - BLACK			•	•	
10	2PLAELDR100330	Twin-wall balanced flue pipe, L= 330 mm., INOX		•		•	
	2PLAELDR100330NO	Twin-wall balanced flue pipe, L= 330 mm., INOX - BLACK			•	•	
10	2PLAELDR100500	Twin-wall balanced flue pipe, L= 500 mm., INOX		•		•	
	2PLAELDR100500NO	Twin-wall balanced flue pipe, L= 500 mm., INOX - BLACK			•	•	

Fig. No.	Modinox Art./ Order No.	Description		Color (*)		Application	
				stainles steel	antr.	rigid	flex
11	2PLAELDR1001000	Twin-wall balanced flue pipe, L= 1000 mm., INOX		•		•	
	2PLAELDR1001000NO	Twin-wall balanced flue pipe, L= 1000 mm., INOX - BLACK			•	•	
12	2PLAELRE100500	Telescopic twin-wall balanced flue pipe, L= min. 300 / max. 500 mm., INOX		•		•	
	2PLAELRE100500NO	Telescopic twin-wall balanced flue pipe, L= min. 300 / max. 500 mm., INOX - BLACK			•	•	
14	2PLACO90100	Twin-wall balanced flue elbow 90°, INOX		•		•	
	2PLACO90100NO	Twin-wall balanced flue elbow 90°, INOX - BLACK			•	•	
15	2PLACO45100	Twin-wall balanced flue elbow 45°, INOX		•		•	
	2PLACO45100NO	Twin-wall balanced flue elbow 45°, INOX - BLACK			•	•	
15	2PLACO30100	Twin-wall balanced flue elbow 30°, INOX		•		•	
	2PLACO30100NO	Twin-wall balanced flue elbow 30°, INOX - BLACK			•	•	

Fig. No.	Modinox Art./ Order No.	Description		Color (*)		Application	
				stainles steel	antr.	rigid	flex
15	2PLACO15100	Twin-wall balanced flue elbow 15°, IN-OX		•		•	
	2PLACO15100NO	Twin-wall balanced flue elbow 15°, IN-OX - BLACK			•	•	
16	2PLACHAR100	Vertical (roof) termination cap, L= 360 mm, INOX		•		•	
	2PLACHAR100NO	Vertical (roof) termination cap, L= 360 mm, INOX - BLACK			•	•	
17	2DIVS5IN150	Roof flashing for a roof pitch of 5°- 30°, IN-OX		•		•	
	2DIVS5IN150NO	Roof flashing for a roof pitch of 5°- 30°, IN-OX - BLACK			•	•	
17	2DIVS3IN150	Roof flashing for a roof pitch of 31°- 45°, INOX		•		•	
	2DIVS3IN150NO	Roof flashing for a roof pitch of 31°- 45°, INOX - BLACK			•	•	
17	2DIVRTS1	Roof tile fitting for roof flashing			•	•	
17	2DIVCSOL153	Collar for roof flashing, IN-OX		•		•	
	2DIVCSOL153NO	Collar for roof flashing, IN-OX - BLACK		•		•	
	2DIVJOCO155	Sealing ring for collar roof flashing				•	

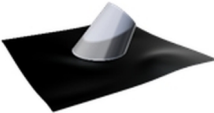
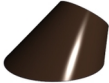
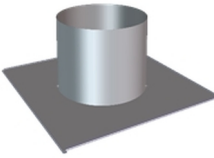
Fig. No.	Modinox Art./ Order No.	Description		Color (*)		Application	
				stainles steel	antr.	rigid	flex
17	2DIVS5PS160	Roof flashing, standard model, lead: 0,6mm thick, for a roof pitch of 5° - 30°, with INOX cone		•		•	
	2DIVS5PR160	Roof flashing, large tile model, lead: 1,0mm thick, for a roof pitch of 5° - 30°, with INOX cone		•		•	
	2DIVS3PS160	Roof flashing, standard model, lead: 0,6mm thick, for a roof pitch of 31° - 45°, with INOX cone		•		•	
	2DIVS3PR160	Roof flashing, large tile model, lead: 1,0mm thick, for a roof pitch of 31° - 45°, with INOX cone		•		•	
17	2DIVC5LA153NO	Cone cover for roof flashing, lead, for a roof pitch of 5° - 30°, INOX - BLACK				•	•
	2DIVC3LA153NO	Cone cover for roof flashing, lead, for a roof pitch of 31° - 45°, INOX - BLACK				•	•
18	2DIVSOIN150	Roof flashing for existing chimney or flat roof, INOX		•		•	
	2DIVSOIN150NO	Roof flashing for existing chimney or flat roof, INOX - BLACK				•	•

Fig. No.	Modinox Art./ Order No.	Description		Color (*)		Application	
				stainless steel	antr.	rigid	flex
19	2PLATHOR100	Horizontal (wall) termination kit, with rosettes, L= min. 580 mm / max. 780 mm. INOX		•		•	
	2PLATHOR100NO	Horizontal (wall) termination kit, with rosettes, L= min. 580 mm / max. 780 mm. INOX - BLACK			•	•	
20	2PLACOJO100	Locking band, quick-fastening. INOX		•		•	
	2PLACOJO100NO	Locking band, quick-fastening. INOX - BLACK			•	•	
21	2PLAJOIF100	Fiber seal				•	
23	2PLACOMU100	Wall strap, INOX		•		•	
	2PLACOMU100NO	Wall strap, INOX - BLACK			•	•	
23	2PLASUPLR100	Wall support, quick fastening		•		•	
24	2PLACOCF100	Set of ceiling finishing plates / Fire stops		•		•	
24	2PLAPVEN100	Ceiling finishing plate with ventilation openings		•		•	

Fig. No.	Modinox Art./ Order No.	Description		Color (*)		Application	
				stainles steel	antr.	rigid	flex
24	2PLAROSA100BT	Rosette, IN-OX		•		•	
	2PLAROSA100BTNO	Rosette, IN-OX - BLACK			•	•	
	2PLAROSA100BTBL	Rosette, IN-OX - WHITE				•	
24	2PLAROSA100	Rosette with 4 mounting holes, INOX		•		•	
	2PLAROSA100NO	Rosette with 4 mounting holes, INOX - BLACK			•	•	
	2PLAROSA100BL	Rosette with 4 mounting holes, INOX - WHITE				•	
34	2PLAEMES100	Concentric pipe with gauging orifice, L= 250 mm, INOX		•		•	
	2PLAEMES100NO	Concentric pipe with gauging orifice, L= 250 mm, INOX - BLACK			•	•	
35	2PLAERAM100	Concentric pipe with inspection/ cleaning opening, L= 260 mm.		•		•	
36	2PLACOSO100	Floor support strap		•		•	
36	2PLACTOS100	Roof strap		•		•	


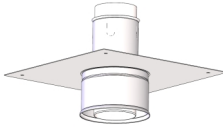
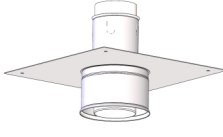
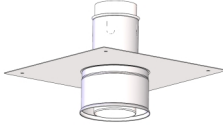
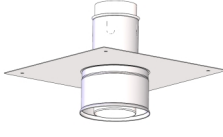
Fig. No.	Modinox Art./ Order No.	Description		Color (*)		Application	
				stainles steel	antr.	rigid	flex
36	2PLAEPDS100	Clearance roof/floor pas-sage		•		•	
25	2PLAADA71002020	Adapter Modi-nox PLA → Flexible pipe, with chimney bottom finish-ing plate 200x200mm, INOX		•		•	•
	2PLAADA71002020NO	Adapter Modi-nox PLA → Flexible pipe, with chimney bottom finish-ing plate 200x200mm, INOX - BLACK			•	•	•
25	2PLAADA71002525	Adapter Modi-nox PLA → Flexible pipe, with chimney bottom finish-ing plate 250x250mm, INOX		•		•	•
	2PLAADA71002525NO	Adapter Modi-nox PLA → Flexible pipe, with chimney bottom finish-ing plate 250x250mm, INOX - BLACK			•	•	•

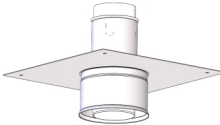
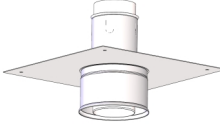
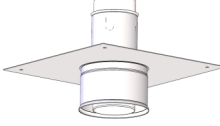
Fig. No.	Modinox Art./ Order No.	Description		Color (*)		Application	
				stainles steel	antr.	rigid	flex
25	2PLAADA71003030	Adapter Modinox PLA → Flexible pipe, with chimney bottom finishing plate 300x300mm, INOX		•		•	•
	2PLAADA71003030NO	Adapter Modinox PLA → Flexible pipe, with chimney bottom finishing plate 300x300mm, INOX - BLACK			•	•	•
25	2PLAADA71002040	Adapter Modinox PLA → Flexible pipe, with chimney bottom finishing plate 200x400mm, INOX		•		•	•
	2PLAADA71002040NO	Adapter Modinox PLA → Flexible pipe, with chimney bottom finishing plate 200x400mm, INOX - BLACK			•	•	•
25	2PLAADA71003040	Adapter Modinox PLA → Flexible pipe, with chimney bottom finishing plate 300x400mm, INOX		•		•	•
	2PLAADA71003040NO	Adapter Modinox PLA → Flexible pipe, with chimney bottom finishing plate 300x400mm, INOX - BLACK			•	•	•

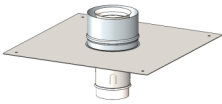
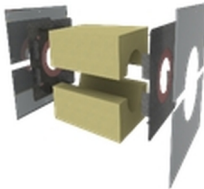
Fig. No.	Modinox Art./ Order No.	Description		Color (*)		Application	
				stainless steel	antr.	rigid	flex
25	2PLAADA61002020	Adapter Flexible pipe → Modinox PLA, with chimney top finishing plate 200x200mm, INOX		•		•	•
	2PLAADA61002525	Adapter Flexible pipe → Modinox PLA, with chimney top finishing plate 250x250mm, INOX		•		•	•
	2PLAADA61003030	Adapter Flexible pipe → Modinox PLA, with chimney top finishing plate 300x300mm, INOX		•		•	•
	2PLAADA61002040	Adapter Flexible pipe → Modinox PLA, with chimney top finishing plate 200x400mm, INOX		•		•	•
	2PLAADA61003040	Adapter Flexible pipe → Modinox PLA, with chimney top finishing plate 300x400mm, INOX		•		•	•
	2PTGKIMU100	Insulation kit ISOMU for wall passage		•		•	

Fig. No.	Modinox Art./ Order No.	Description		Color (*)		Application	
				stainless steel	antr.	rigid	flex
	2PTGKIRA100 + la pente	Insulation kit ISORA for pitched roof passage		•		•	
	2PTGKIRAV100 + la pente	Insulation kit ISORA for pitched roof passage, roof and floor, includes a junction collar and 4 ventilation grilles		•		•	
	2PTGKIFO100	Insulation kit FOURP for ceiling passage. Complete wood floor kit		•		•	
	2PTGKIFO100BE	Insulation kit FOURP for ceiling passage. Complete concrete floor kit		•		•	
	2PTGKIFOV100	Insulation kit FOURP for ceiling + storey floor passage. Complete wood floor kit		•		•	
	2PTGKIFOVBE100	Insulation kit FOURP for ceiling + storey floor passage. Complete concrete floor kit		•		•	
	2PTGPPDR100BL	Ceiling finishing plates - Whit lacquered - Option for kit FOURP		•		•	

6.13

Modinox - PLA system Ø130 - Ø200



Fig. No.	Modinox Art./ Order No.	Description		Color (*)		Application	
				stainless steel	antr.	rigid	flex
	2PLAMAFM130BEL	Bellfires appliance connection: Adapter Bellfires Ø130/200 mm → Modinox PLA Ø130/200 mm. L= 230 mm. INOX		•		•	
	2PLAMAFM130BELNO	Bellfires appliance connection: Adapter Bellfires Ø130/200 mm → Modinox PLA Ø130/200 mm. L= 230 mm. INOX - BLACK				•	•
100	2PLAMAFM130100BEL	Bellfires appliance connection: Adapter Bellfires Ø130/200 mm → Modinox PLA Ø100/153 mm. L= 180 mm. INOX		•		•	
	2PLAMAFM130100BELNO	Bellfires appliance connection: Adapter Bellfires Ø130/200 mm → Modinox PLA Ø100/153 mm. L= 180 mm. INOX - BLACK				•	•

Fig. No.	Modinox Art./ Order No.	Description		Color (*)		Application	
				stainless steel	antr.	rigid	flex
100	2PLAMAFM130100	Adapter Modinox PLA Ø130/200 mm → Modinox PLA Ø100/153 mm. L= 225 mm. INOX		•		•	
	2PLAMAFM130100NO	Adapter Modinox PLA Ø130/200 mm → Modinox PLA Ø100/153 mm. L= 225 mm. INOX - BLACK				•	•
110	2PLAELDR130250	Twin-wall balanced flue pipe, L= 250 mm., INOX		•		•	
	2PLAELDR130250NO	Twin-wall balanced flue pipe, L= 250 mm., INOX - BLACK				•	•
110	2PLAELDR130330	Twin-wall balanced flue pipe, L= 330 mm., INOX		•		•	
	2PLAELDR130330NO	Twin-wall balanced flue pipe, L= 330 mm., INOX - BLACK				•	•
110	2PLAELDR130500	Twin-wall balanced flue pipe, L= 500 mm., INOX		•		•	
	2PLAELDR130500NO	Twin-wall balanced flue pipe, L= 500 mm., INOX - BLACK				•	•
111	2PLAELDR1301000	Twin-wall balanced flue pipe, L= 1000 mm., INOX		•		•	
	2PLAELDR1301000NO	Twin-wall balanced flue pipe, L= 1000 mm., INOX - BLACK				•	•

Fig. No.	Modinox Art./ Order No.	Description		Color (*)		Application	
				stainless steel	antr.	rigid	flex
112	2PLAELRE130500	Telescopic twin-wall balanced flue pipe, L= min. 300 / max. 500 mm., IN-OX		•		•	
	2PLAELRE130500NO	Telescopic twin-wall balanced flue pipe, L= min. 300 / max. 500 mm., IN-OX - BLACK			•	•	
114	2PLACO90130	Twin-wall balanced flue elbow 90°, IN-OX		•		•	
	2PLACO90130NO	Twin-wall balanced flue elbow 90°, IN-OX - BLACK			•	•	
115	2PLACO45130	Twin-wall balanced flue elbow 45°, IN-OX		•		•	
	2PLACO45130NO	Twin-wall balanced flue elbow 45°, IN-OX - BLACK			•	•	
115	2PLACO30130	Twin-wall balanced flue elbow 30°, IN-OX		•		•	
	2PLACO30130NO	Twin-wall balanced flue elbow 30°, IN-OX - BLACK			•	•	
115	2PLACO15130	Twin-wall balanced flue elbow 15°, IN-OX		•		•	
	2PLACO15130NO	Twin-wall balanced flue elbow 15°, IN-OX - BLACK			•	•	

Fig. No.	Modinox Art./ Order No.	Description		Color (*)		Application	
				stainless steel	antr.	rigid	flex
116	2PLACHAR130	Vertical (roof) termination cap, L= 360 mm, INOX		•		•	
	2PLACHAR130NO	Vertical (roof) termination cap, L= 360 mm, INOX - BLACK			•	•	
117	2DIVS5IN200	Roof flashing for a roof pitch of 5°-30°, INOX		•		•	
	2DIVS5IN200NO	Roof flashing for a roof pitch of 5°-30°, INOX - BLACK			•	•	
117	2DIVS3IN200	Roof flashing for a roof pitch of 31°-45°, INOX		•		•	
	2DIVS3IN200NO	Roof flashing for a roof pitch of 31°-45°, INOX - BLACK			•	•	
117	2DIVRTS1	Roof tile fitting for roof flashing				•	•
117	2DIVCSOL200	Collar for roof flashing, INOX		•		•	
	2DIVCSOL200NO	Collar for roof flashing, INOX - BLACK		•		•	
	2DIVJOCO205	Sealing ring for collar roof flashing				•	

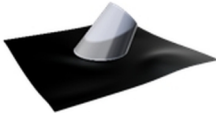
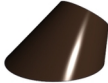
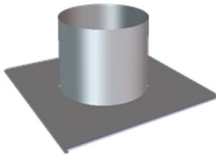
Fig. No.	Modinox Art./ Order No.	Description		Color (*)		Application	
				stainless steel	antr.	rigid	flex
117	2DIVS5PS200	Roof flashing, standard model, lead: 0,6mm thick, for a roof pitch of 5°- 30°, with IN-OX cone		•		•	
	2DIVS5PR210	Roof flashing, large tile model, lead: 1,0mm thick, for a roof pitch of 5°- 30°, with IN-OX cone		•		•	
	2DIVS3PS200	Roof flashing, standard model, lead: 0,6mm thick, for a roof pitch of 31°- 45°, with IN-OX cone		•		•	
	2DIVS3PR210	Roof flashing, large tile model, lead: 1,0mm thick, for a roof pitch of 31°- 45°, with IN-OX cone		•		•	
117	2DIVC5LA200NO	Cone cover for roof flashing, lead, for a roof pitch of 5°- 30°, INOX - BLACK				•	•
	2DIVC3LA200NO	Cone cover for roof flashing, lead, for a roof pitch of 31°- 45°, INOX - BLACK				•	•
118	2DIVSOIN200	Roof flashing for existing chimney or flat roof, INOX		•		•	
	2DIVSOIN200NO	Roof flashing for existing chimney or flat roof, INOX - BLACK				•	•

Fig. No.	Modinox Art./ Order No.	Description		Color (*)		Application	
				stainless steel	antr.	rigid	flex
119	2PLATHOR130	Horizontal (wall) termination kit, with rosettes, L= min. 580 mm / max. 780 mm. INOX		•		•	
	2PLATHOR130NO	Horizontal (wall) termination kit, with rosettes, L= min. 580 mm / max. 780 mm. INOX - BLACK			•	•	
120	2PLACOJO130	Locking band, quick-fastening. INOX		•		•	
	2PLACOJO130NO	Locking band, quick-fastening. INOX - BLACK			•	•	
121	2PLAJOIF130	Fiber seal				•	
123	2PLACOMU130	Wall strap, INOX		•		•	
	2PLACOMU130NO	Wall strap, INOX - BLACK			•	•	
123	2PLASUPLR130	Wall support, quick fastening		•		•	
124	2PLACOCF130	Set of ceiling finishing plates / Fire stops		•		•	
124	2PLAPVEN130	Ceiling finishing plate with ventilation openings		•		•	

Fig. No.	Modinox Art./ Order No.	Description		Color (*)		Application	
				stainless steel	antr.	rigid	flex
124	2PLAROSA130BT	Rosette, IN-OX		•		•	
	2PLAROSA130BTNO	Rosette, IN-OX - BLACK			•	•	
	2PLAROSA130BTBL	Rosette, IN-OX - WHITE				•	
124	2PLAROSA130	Rosette with 4 mounting holes, INOX		•		•	
	2PLAROSA130NO	Rosette with 4 mounting holes, INOX - BLACK			•	•	
	2PLAROSA130BL	Rosette with 4 mounting holes, INOX - WHITE				•	
134	2PLAEMES130	Concentric pipe with gauging orifice, L= 250 mm, INOX		•		•	
	2PLAEMES130NO	Concentric pipe with gauging orifice, L= 250 mm, INOX - BLACK			•	•	
135	2PLAERAM130	Concentric pipe with inspection/cleaning opening, L= 260 mm.		•		•	
136	2PLACOSO130	Floor support strap		•		•	
136	2PLACTOS130	Roof strap		•		•	


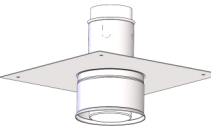
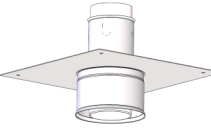
Fig. No.	Modinox Art./ Order No.	Description		Color (*)		Application	
				stainless steel	antr.	rigid	flex
136	2PLAEPDS130	Clearance roof/floor passage		•		•	
125	2PLAADA71302020	Adapter Modinox PLA → Flexible pipe, with chimney bottom finishing plate 200x200mm, INOX		•		•	•
	2PLAADA71302020NO	Adapter Modinox PLA → Flexible pipe, with chimney bottom finishing plate 200x200mm, INOX - BLACK				•	•
125	2PLAADA71302525	Adapter Modinox PLA → Flexible pipe, with chimney bottom finishing plate 250x250mm, INOX		•		•	•
	2PLAADA71302525NO	Adapter Modinox PLA → Flexible pipe, with chimney bottom finishing plate 250x250mm, INOX - BLACK				•	•

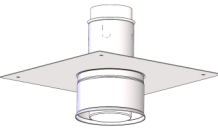
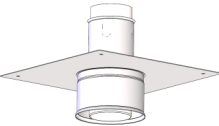
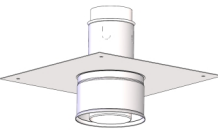
Fig. No.	Modinox Art./ Order No.	Description		Color (*)		Application	
				stainless steel	antr.	rigid	flex
125	2PLAADA71303030	Adapter Modinox PLA → Flexible pipe, with chimney bottom finishing plate 300x300mm, INOX		•		•	•
	2PLAADA71303030NO	Adapter Modinox PLA → Flexible pipe, with chimney bottom finishing plate 300x300mm, INOX - BLACK			•	•	•
125	2PLAADA71302040	Adapter Modinox PLA → Flexible pipe, with chimney bottom finishing plate 200x400mm, INOX		•		•	•
	2PLAADA71302040NO	Adapter Modinox PLA → Flexible pipe, with chimney bottom finishing plate 200x400mm, INOX - BLACK			•	•	•
125	2PLAADA71303040	Adapter Modinox PLA → Flexible pipe, with chimney bottom finishing plate 300x400mm, INOX		•		•	•
	2PLAADA71303040NO	Adapter Modinox PLA → Flexible pipe, with chimney bottom finishing plate 300x400mm, INOX - BLACK			•	•	•

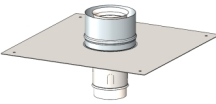
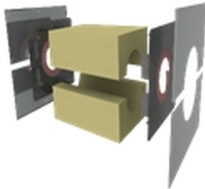
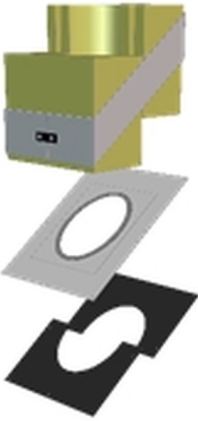
Fig. No.	Modinox Art./ Order No.	Description		Color (*)		Application	
				stainless steel	antr.	rigid	flex
125	2PLAADA61302020	Adapter Flexible pipe → Modinox PLA, with chimney top finishing plate 200x200mm, INOX		•		•	•
	2PLAADA61302525	Adapter Flexible pipe → Modinox PLA, with chimney top finishing plate 250x250mm, INOX		•		•	•
	2PLAADA61303030	Adapter Flexible pipe → Modinox PLA, with chimney top finishing plate 300x300mm, INOX		•		•	•
	2PLAADA61302040	Adapter Flexible pipe → Modinox PLA, with chimney top finishing plate 200x400mm, INOX		•		•	•
	2PLAADA61303040	Adapter Flexible pipe → Modinox PLA, with chimney top finishing plate 300x400mm, INOX		•		•	•
	2PTGKIMU130	Insulation kit ISOMU for wall passage		•		•	

Fig. No.	Modinox Art./ Order No.	Description		Color (*)		Application	
				stainless steel	antr.	rigid	flex
	2PTGKIRA130 + la pente	Insulation kit ISORA for pitched roof passage		•		•	
	2PTGKIRAV130 + la pente	Insulation kit ISORA for pitched roof passage, roof and floor, includes a junction collar and 4 ventilation grilles		•		•	
	2PTGKIFO130	Insulation kit FOURP for ceiling passage. Complete wood floor kit		•		•	
	2PTGKIFO130BE	Insulation kit FOURP for ceiling passage. Complete concrete floor kit		•		•	
	2PTGKIFOV130	Insulation kit FOURP for ceiling + storey floor passage. Complete wood floor kit		•		•	
	2PTGKIFOVBE130	Insulation kit FOURP for ceiling + storey floor passage. Complete concrete floor kit		•		•	
	2PTGPPDR130BL	Ceiling finishing plates - White lacquered - Option for kit FOURP		•		•	

barbas .

Your Barbas dealer