

## Gyrofocus gas fireplace with chimney fan

Freedom of design with an exodraft chimney fan

**focus**<sup>®</sup>

**exodraft**



## FACTS ABOUT EXODRAFT FANS



### FREEDOM OF DESIGN

Vertical and horizontal flue runs with multiple elbows.



### BETTER COMBUSTION

Optimal draught to fireplace in all weather conditions.



### INCREASED SAFETY

Constant monitoring of flow and automatic shutdown. Approved according to Gas Appliance Directive.



### ATTRACTIVE DESIGN

All fans have a compact form factor and a sleek design. Pick your colour.

Maintenance-free

Easy to install



2 YEAR WARRANTY

Available in all RAL colours on request



Option A:  
RSHG/RSVG fan mounted on  
roof at the end of flue run



Option B:  
RSG fan mounted on external  
wall at the end of flue run

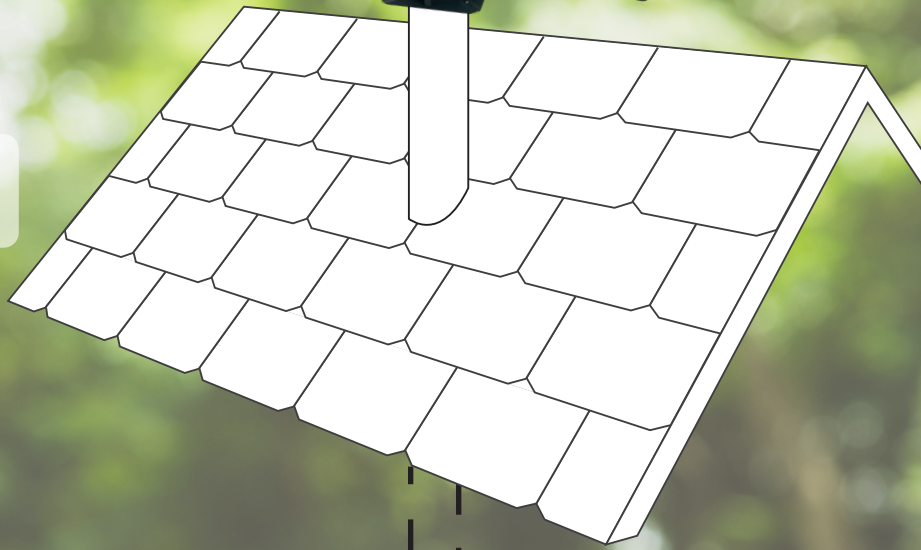
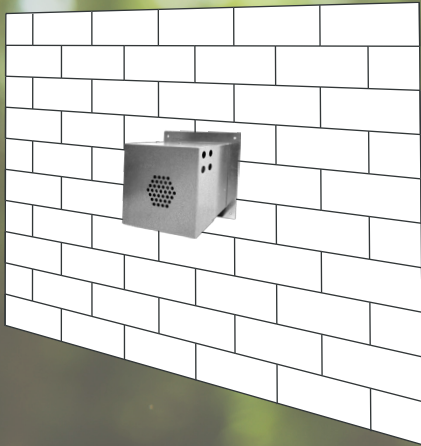



## More options for fireplace placement

With the possibility of both vertical and horizontal flue runs with multiple bends, the placement of your fireplace is no longer limited by the location of your chimney.

 Gyrofocus Gas Fire

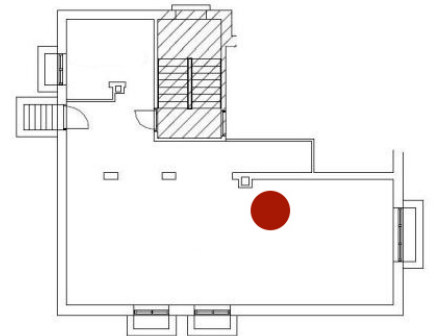
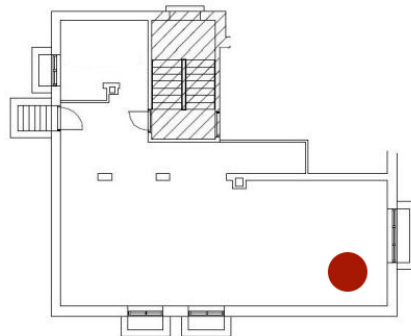
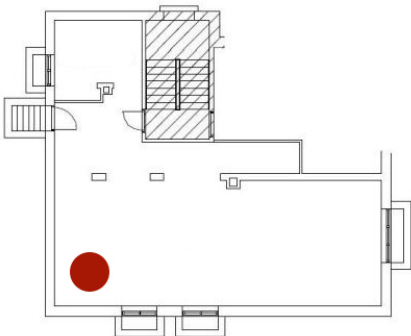

# The chimney fan ensures your family's safety

**exodraft** is the only system on the market which has an approved fail-safe function. The system is used to secure the safety of the new fireplace.

An **exodraft** chimney fan system gives you the freedom to choose a gas fireplace based on your needs rather than the limitations imposed by the building's design and construction.

## A safe fireplace with built in freedom of choice

**Enjoy the pleasure of an open fire – also without a traditional chimney**

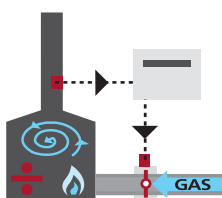

### **Safety** – a secure failsafe system

The chimney fan's control system automatically shuts off the gas if there is insufficient updraught in the chimney, always ensuring that your gas fire operates correctly. The **exodraft** system is the only approved system currently available.



### **Solves all spillage problems**

The chimney fan system creates optimal updraught in your chimney regardless of wind and weather conditions, thus eliminating all down draught into your living room.

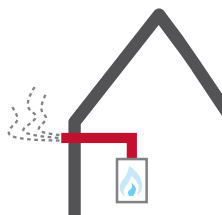

### **No chimney required**

The chimney fan system works equally when installed on a traditional chimney or attached to an outside wall – giving you the freedom to choose the gas fireplace that suits your needs.



### **Healthy indoor environment**

Thanks to a continuous updraught created by the chimney fan system all harmful gas fumes are removed to enhance a healthy indoor environment.

# Chimney fan systems

## – with or without a chimney

**exodraft** chimney fan systems consist of the chimney fan, a gas controller and a gas solenoid valve.

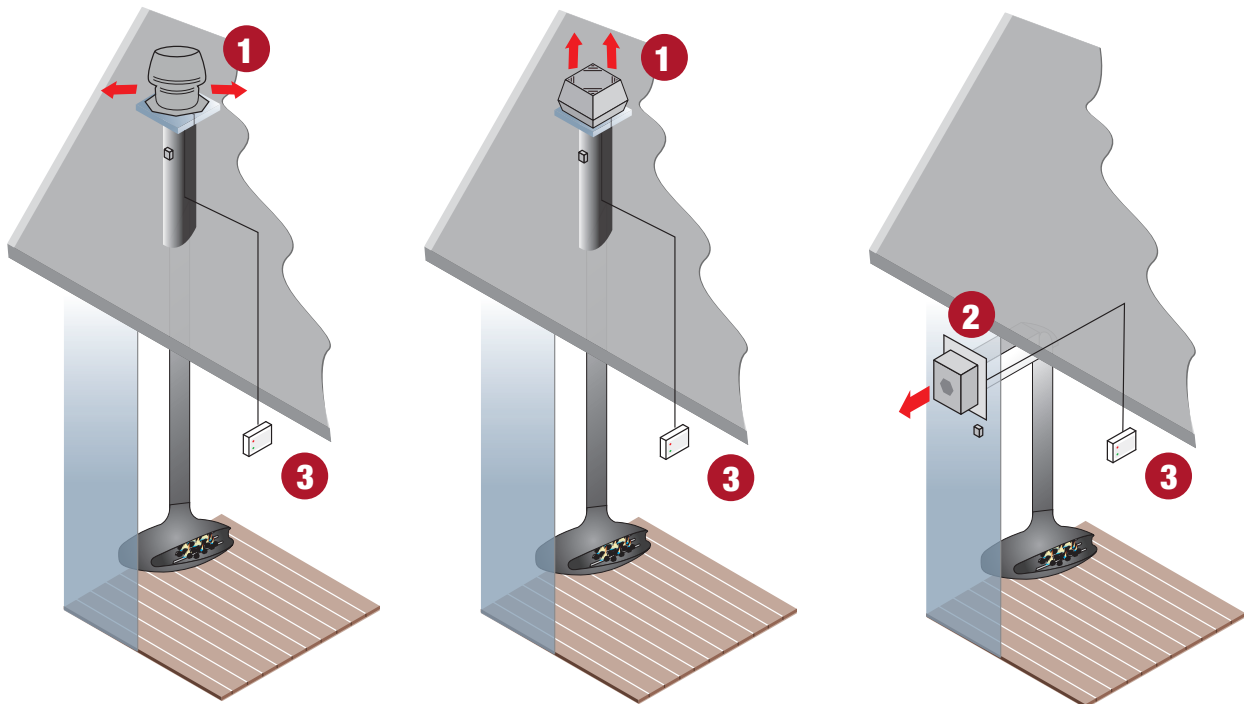

Chimney fan system with horizontal extraction via a steel chimney

Chimney fan system with vertical extraction via a steel chimney

Chimney fan system with extraction via an external wall where there is no chimney



The chimney fan is available in 3 versions – for vertical or horizontal discharge via a steel chimney or for discharge through an external wall. All versions are available in a wide range of sizes that matches all types of fireplaces.

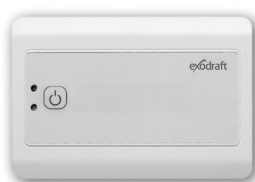

**3**  
EFC21

The chimney fan controller ensures fail-safe control of your fire. When switched on a signal is sent to the chimney fan to create the optimal updraft in the chimney. When this is achieved the control system will allow gas into the gas fire enabling the gas fire to lit. Any reduction in the updraft will result in the gas supply being cut and the fireplace will switch off. This is the only system on the market that have attained the GASTEC approval in accordance with EN298.



## Connection to gas controller

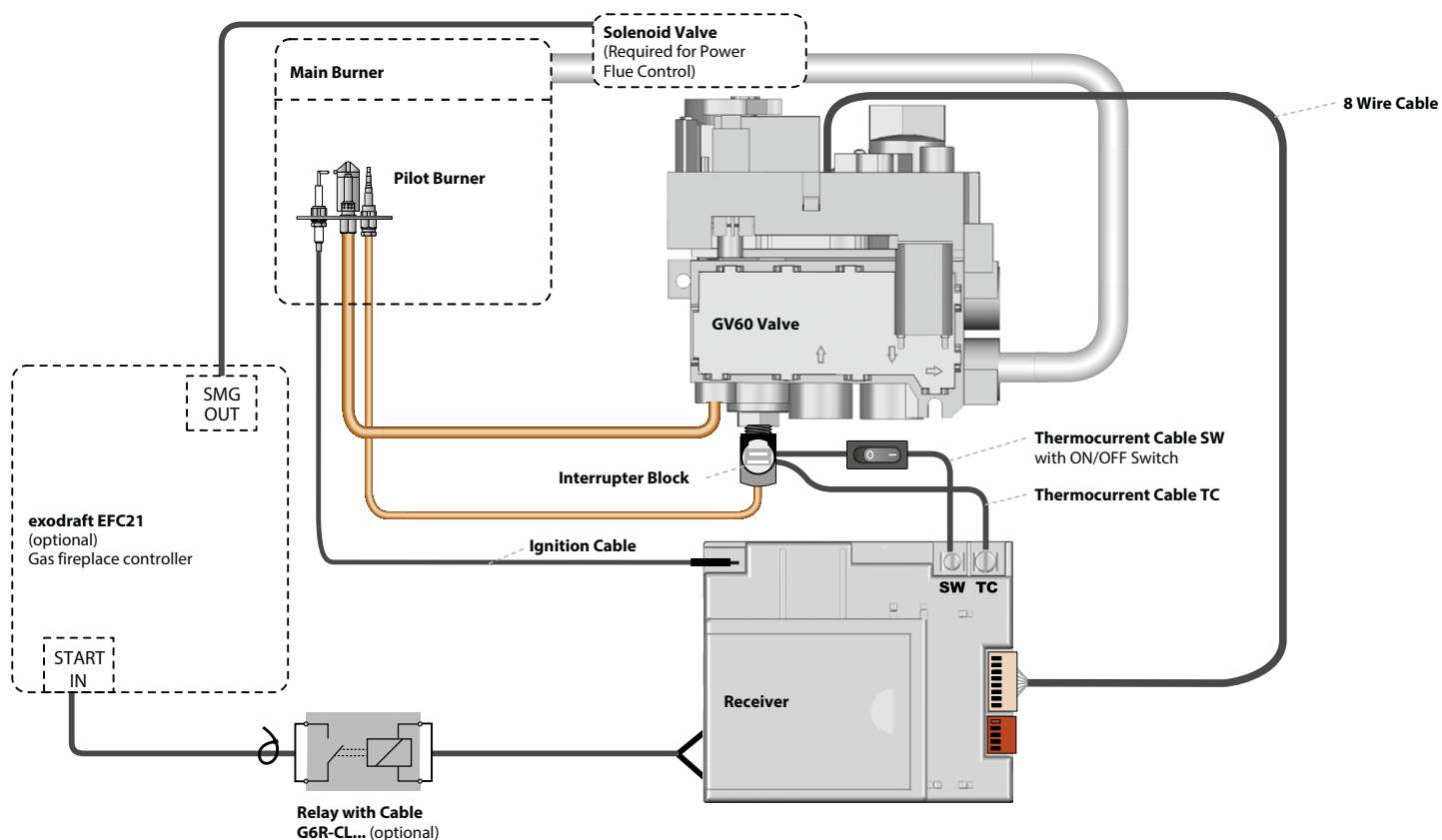

### Function:

Using the remote to start the fireplace a radio signal is sent to the receiver, making the fan start and create the correct chimney draught. This is achieved within a few seconds and the gas fireplace will automatically ignite.

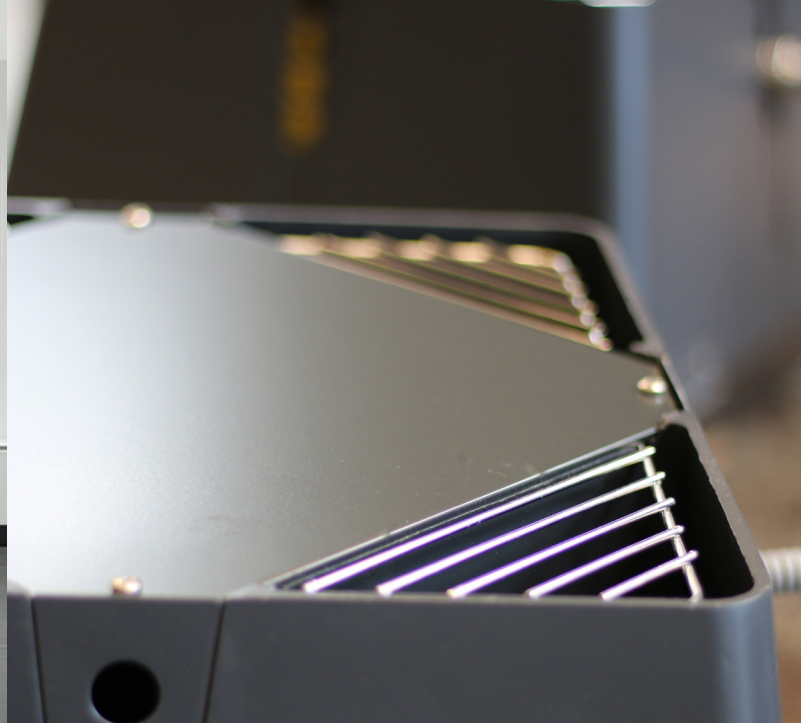

For further advice and calculation of your system,  
please contact our technical teams.

**focus**®

Visit our website for more information:  
[www.gyrofocust-gaz.com](http://www.gyrofocust-gaz.com)

Atelier Dominique Imbert  
3, impasse Claque Patin  
F-34380 Viols le Fort  
Tel: +33 (0)4 67 55 01 93  
Fax: +33 (0)4 67 55 77 77  
[order@focus-creation.com](mailto:order@focus-creation.com)  
[www.focus-fireplaces.com](http://www.focus-fireplaces.com)

**exodraft**

Visit our website for more information:  
[www.exodraft.com](http://www.exodraft.com)

**DK:** exodraft a/s  
Industrivej 10  
DK-5550 Langeskov  
Tel: +45 7010 2234  
Fax: +45 7010 2235  
[info@exodraft.dk](mailto:info@exodraft.dk)  
[www.exodraft.dk](http://www.exodraft.dk)

**NO:** exodraft a/s  
Storgaten 88  
N-3060 Svelvik  
Tel: +47 3329 7062  
[info@exodraft.no](mailto:info@exodraft.no)  
[www.exodraft.no](http://www.exodraft.no)

**SE:** exodraft a/s  
Kalendevägen 2  
SE-302 39 Halmstad  
Tlf: +46 (0)8-5000 1520  
[info@exodraft.se](mailto:info@exodraft.se)  
[www.exodraft.se](http://www.exodraft.se)

**UK:** exodraft Ltd.  
24 Janes Meadow, Tarleton  
GB-Preston PR4 6ND  
Tel: +44 (0)1494 465 166  
Fax: +44 (0)1494 465 163  
[info@exodraft.co.uk](mailto:info@exodraft.co.uk)  
[www.exodraft.co.uk](http://www.exodraft.co.uk)

**DE:** exodraft a/s  
Niederlassung Deutschland  
Soonwaldstr. 6  
DE-55569 Monzingen  
Tel: +49 (0)6751 855 599-0  
Fax: +49 (0)6751 855 599-9  
[info@exodraft.de](mailto:info@exodraft.de)

[www.exodraft.de](http://www.exodraft.de)  
**FR:** exodraft sas  
78, rue Paul Jozon  
F-77300 Fontainebleau  
Tel: +33 (0)6 3852 3860  
[info@exodraft.fr](mailto:info@exodraft.fr)  
[www.exodraft.fr](http://www.exodraft.fr)